

CATALOGO 2022



ROTONDI

ROUND

Ø 180	Art. 111	61
Ø 200	Art. 6	57
	Art. 7	58
	Art. 12	56
	Art. 27	35
	Art. 42B	39
	Art. 72	55
	Art. 84	37
	Art. 92	52
	Art. 102	51/53
	Art. 112	61
	Art. 134	47
	Art. 172	48/49
	Art. 181	62/63
Ø 230/250	Art. 28	34
	Art. 55	40
	Art. 56	41
	Art. 75/6	54
	Art. 114	61
	Art. 135/6	46
	Art. 182A	62
Ø 280/300	Art. 29	35
	Art. 45B	39
	Art. 66	30
	Art. 85	37
	Art. 175	48/49

RETTANGOLARI

RECTANGULAR

185x125	Art. 113R	60
210x130	Art. 44 BR	38
	Art. 114R	59
240x150	Art. 66R	31
	Art. 86R	36
	Art. 106RSA	50
	Art. 115R	59
	Art. 136R	45
300x200	Art. 138R	44
	Art. 152R	26/27
400x300	Art. 140R	28/29
	Art. 154R	26/27
	Art. 156R	22/23
	Art. 176R	24/25

SEMIQUADRI

HALF SQUARE

Ø 200	Art. 18	42
--------------	---------	----

QUADRATI

SQUARE

155x155	Art. 113Q	60
200x200	Art. 46BQ	38
	Art. 66Q	31
	Art. 106QSA	50
	Art. 136Q	45
225x225	Art. 138Q	43
300x300	Art. 139Q	28/29
	Art. 153Q	26/27
	Art. 155Q	22/23
	Art. 175Q	24/25
400x400	Art. 141Q	28/29
	Art. 154-4	26/27

LATERALI QUADRATI

SIDE POLE SQUARE

200x200	Art. 137Q-200	13
250x250	Art. 87Q	12
	Art. 127Q	14
	Art. 137Q	13
260x260	Art. 137Q-ICE	16
300x300	Art. 157Q	6
	Art. 188Q	8
	Art. 208Q	10
	Art. 448Q	18
400x400	Art. 159Q	6

LATERALI RETTANGOLARI

SIDE POLE RECTANGULAR

300x200	Art. 87R	12
	Art. 127R	14
	Art. 137R	13
300x400	Art. 158R	6
	Art. 189R	8
	Art. 209R	10
	Art. 449R	18

INDICE

Ombrelloni laterali
Side pole parasols
Pag. 4 - 19



Vele
Shade sails
Pag. 66

Ombrelloni grandi
Market parasols
Pag. 20 - 31



Cuscini
Cushions
Pag. 67-69

Ombrelloni design
Design parasols
Pag. 32 - 47



Fodere
Covers
Pag. 70-75

Ombrelloni professionali e classici
Professional and classic parasols
Pag. 48 - 63



Basi
Bases
Pag. 76-79

INDEX

(I) Spiegazione dati tecnici contenuti nelle schede prodotto.

Peso tessuto: è al mq

Colori: la resistenza è espressa sulla scala il cui valore massimo è 8. Solo i tessuti AcrilMa e Pool hanno colori garantiti contro lo scolorimento.

Protezione UV: indica la protezione dai raggi UV per le persone. Il valore UPF indicato è secondo la norma AS/NZS il cui valore massimo è 50+ (eccellente).

Dimensione: indichiamo sempre la dimensione tecnica del prodotto, ricavata dalla lunghezza della stecca. La dimensione reale può differire leggermente per effetto della curvatura o per esigenze di lavorazione, ma è sempre inferiore alle tolleranze ammesse

Peso minimo della base: indichiamo il peso minimo necessario per reggere l'ombrellone in sicurezza in condizioni di montaggio e condizioni meteo normali.

L'ombrellone è sempre venduto senza base. Negli ombrelloni laterali è compresa la struttura metallica della base e sono esclusi i piastrelloni.

(I) Please read the following notes on the technical datas that you find in our catalogue.

Fabric weight: it's per sqm

Colours: we use a scale where the max value is 8. Just our fabrics AcrilMa and Pool are guarantee against colour fading.

UV Protection: it's the protection against UV rays for the people. The given UPF value follows the rules AS/NZS, which have a max value of 50+ (excellent).

Size: we write the technical dimension, that is the rib length. The real size can be a little different because of the camber or technical reasons, but it's ever less than the allowed tolerance.

Base weight: we give the minimum weight in order to hold the parasol in total safety in case of normal assembling conditions and normal meteo conditions.

Our parasols are sold without base. In the side pole parasols the base metal parts are included in the frame, while the stones are not included.

OMBRELLONI LATERALI

Una collezione che soddisfa
le molteplici necessità
dell'arredamento
degli spazi esterni.

SIDE POLE PARASOLS

*A varied collection
to furnish
your outdoors.*







Art. 157Q cm 300x300/8

Art. 158R cm 300x400/8

Art. 159Q cm 400x400/8

TESSUTO

■ Modello **senza volanti:**

PolyMa poliestere gr 210

■ Modello **con volanti:**

Dralon Acrilico gr 300 gr

■ Idrorepellente

■ Antimuffa

■ Resistenza colori 6+

■ Protezione UV 50+

■ Antivento

■ Laccio di chiusura

■ Imballo: 3 scatole

FABRIC

■ Version **without valances:**

PolyMa Polyester 210 gr

■ Version **with valances:**

Dralon Acrylic 300 gr

■ Water repellent

■ Mouldproof

■ Colour fastness 6+

■ UV protection 50+

■ Air-vent

■ Tie-band for closing

■ Packing: 3 cartons

TELAIO: FIBRA DI VETRO

vedi pag 7

Pezzi di ricambio disponibili

FRAME: FIBERGLASS

see pag. 7

Spare parts on demand



Dralon gr 300 con volanti
Dralon gr 300 with valances

Colore / Colour

Colori speciali / Special colours



Ecu
Natural



Bianco
White



Taupe
Taupe

Modello con volanti solo Ecu

Version with valances natural colour only

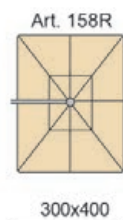
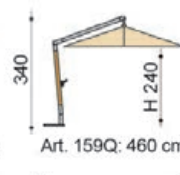
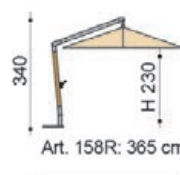
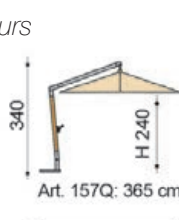

Art. 157Q, 158R, 159Q

La struttura in FIBRA DI VETRO conferisce una resistenza ed elasticità uniche, superiori ad una struttura simile in legno o metallo, grazie alla capacità di questo materiale composito, di assorbire le sollecitazioni improvvise.

The frame made of FIBERGLASS gives excellent elasticity and strenght, much more than similar products, thanks to this composite material resistance to sudden stress.



BACCHETTE

Fibra di vetro intercambiabili, colore teak.

RIBS

Fiberglass exchangeable, teak colour.

PALO

Fibra di vetro mm 91x91 colore teak, con connettori acciaio Dacromet.

POLE

Fiberglass mm 91x91 teak colour, with Dacromet steel connectors.

MANOVELLA-VITI

Scatola e manopola in alluminio, cavo e viti inox.

CRANK-SCREWS

Aluminium box and handle, stainless steel cable and screws.

BASE

Acciaio Dacromet, forma a T, girevole a 360° doppia manopola, piastra per terreni molli inclusa.

BASE

Dacromet steel, T shaped, rotating 360°, with double handle, with plate for soft grounds included.

CONTRAPPESO

> Kg 120 min.

WEIGHT FOR BASE

> 120 Kg min.

OPZIONE

*Copertura in alluminio.

**Plinto.

OPTIONS

*Alu cover.

**Anchor base.

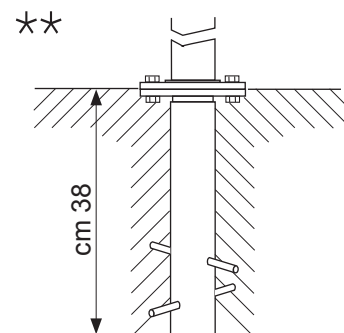



Art. 188Q cm 300x300/8

Art. 189R cm 300x400/8

TESSUTO

- *TexMa Olefin gr 190*
- *Idrorepellente*
- *Antimuffa*
- *Resistenza colori 7+*
- *Protezione UV 50+*
- *Antivento*
- *Laccio di chiusura*
- *Senza volantini*
- *Imballo: 2 cartoni*

TELAIO: ALLUMINIO

vedi pag. 9

Pezzi di ricambio disponibili

Colori / Colours



Ecu
Natural

Taupe
Taupe

Colori su richiesta / Colours on demand



Bianco
White

Brasserie
Brasserie

Grigio
Grey

Lime
Lime

Blu
Blue

FABRIC

- *TexMa Olefin 190 gr*
- *Water repellent*
- *Mouldproof*
- *Colour fastness 7+*
- *UV protection 50+*
- *Air-vent*
- *Tie-band for closing*
- *Without valances*
- *Packing: 2 cartons*

FRAME: ALUMINIUM

see pag. 9

Spare parts on demand

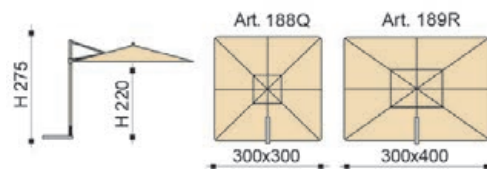

Art. 188Q, Art. 189R

Petra è la serie di ombrelloni laterali retrattili qualità top di Maffei. La struttura è in alluminio, colore platino, apertura semplice con manopola in metallo. È inclinabile ed è dotato di sistema multiposizione sul palo. Le stecche sono intercambiabili e sono agganciate a delle parti centrali metalliche. Il piede è a T per assicurare la massima disponibilità di spazio sotto l'ombrellone. Il tessuto è TexMa tinto in pasta, con un'eccellente resistenza dei colori, eccellente protezione UV e trattamento idrorepellente.

Petra is high quality line of side folding umbrellas by Maffei. Frame is made of aluminium platinum finished. The opening is simple and easy thanks to a metal handle. It is tiltable in different positions. Ribs are exchangeable. The T shaped base increases the usable surface under the umbrella. The canvas is made of solution dyed fabric, TexMa, which has an excellent sun fastness and UV protection. It is also water repellent.



BACCHETTE

Alluminio mm 20x26 intercambiabili.

RIBS

Aluminium mm 20x26 exchangeable.

PALO

Alluminio mm 65x98.

POLE

Aluminium 65x98 mm.

APERTURA

Con manopola scorrevole + manovella.
Inclinazione: multiposizione.

OPENING

By sliding handle + crank. Tilting system multiposition, patented system.

BASE

A T girevole 360°, con pedale e piastra terreni molli in dotazione

BASE

T shaped, 360° rotating. Supplied with pedal and supporting plate for soft grounds.

CONTRAPPESO

Kg 120 min.

WEIGHT FOR BASE

120 Kg min.

OPZIONE

Copribase optional.
Copertura in alluminio ** Plinto

OPTIONS

Base cover in options.
Alu cover ** Anchor base

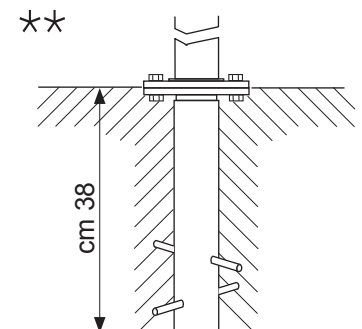
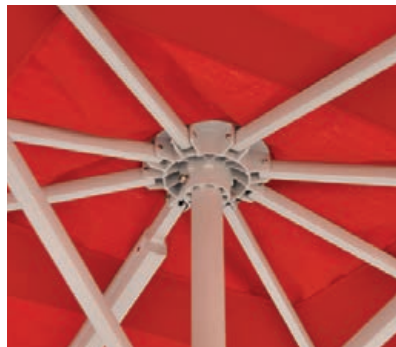



Art. 208Q cm 300x300/8

Art. 209R cm 300x400/8

TESSUTO

- TexMa Olefin gr 190
- Idrorepellente
- Antimuffa
- Resistenza colori 7+
- Protezione UV 50+
- Antivento
- Laccio di chiusura
- Senza volant
- Imballo: 2 cartoni

FABRIC

- TexMa Olefin 190 gr
- Water repellent
- Mouldproof
- Colour fastness 7+
- UV protection 50+
- Air-vent
- Tie-band for closing
- Without valances
- Packing: 2 cartons

TELAIO: ALLUMINIO

vedi pag. 11

Pezzi di ricambio disponibili

Colori / Colours



Ecu Natur Taupe
Taupe

Colori su richiesta / Colours on demand



Terracotta Grigio Antracite Nero
Terracotta Grey Anthracite Black

FRAME: ALUMINIUM

see pag. 11

Spare parts on demand

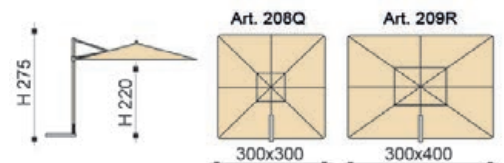

Art. 208Q, Art. 209R

Peter è la serie di ombrelloni laterali retrattili qualità top di Maffei. La struttura è in alluminio, colore grafite, apertura semplice con manopola in metallo. È inclinabile ed è dotato di sistema multiposizione sul palo. Le stecche sono intercambiabili e sono agganciate a delle parti centrali metalliche. Il piede è a T per assicurare la massima disponibilità di spazio sotto l'ombrellone. Il tessuto è TexMa tinto in pasta, con un'eccellente resistenza dei colori, eccellente protezione UV e trattamento idrorepellente.

Peter is high quality line of side folding umbrellas by Maffei. Frame is made of aluminium graphite finished. The opening is simple and easy thanks to a metal handle. It is tiltable in different positions. Ribs are exchangeable. The T shaped base increases the usable surface under the umbrella. The canvas is made of solution dyed fabric, TexMa, which has an excellent sun fastness and UV protection. It is also water repellent.



BACCHETTE

Alluminio mm 20x26 intercambiabili.

RIBS

Aluminium mm 20x26 exchangeable.

PALO

Alluminio mm 65x98.

POLE

Aluminium 65x98 mm.

APERTURA

Con manopola scorrevole + manovella.
Inclinazione: multiposizione.

OPENING

By sliding handle + crank. Tilting system multiposition, patented system.

BASE

A T girevole 360°, con pedale e piastra terreni molli in dotazione

BASE

T shaped, 360° rotating.
Supplied with pedal and supporting plate for soft grounds.

CONTRAPPESO

Kg 120 min.

WEIGHT FOR BASE

120 Kg min.

OPZIONE

Copertura in alluminio
** Piinto

OPTIONS

Alu cover
** Anchor base

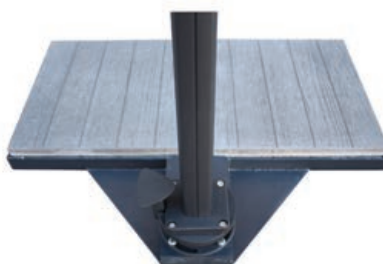



ESCLUSIVO MAFFEI
MAFFEI EXCLUSIVITY



Art. 87R - cm 300x200

Art. 87Q cm 250x250/4

Art. 87R cm 300x200/4

TESSUTO

- Tessuto gr 190/210 (vedere dettagli su schema colori)
- Resistenza colori 5-7
- Protezione UV 50+
- Laccio di chiusura
- Con volanti Allegro
- Imballo: 1 scatola

FABRIC

- Fabric 190/210 gr (see details on colour scheme)
- Colour fastness 5-7
- UV protection 50+
- Tie-band for closing
- With valances Allegro
- Packing: 1 carton

TELAIO: ALLUMINIO

vedi pag. 15

Pezzi di ricambio disponibili

FRAME: ALUMINIUM

see pag. 15

Spare parts on demand

Colori / Colours Art 87Q



Colori / Colours Art 87R



P = PolyMa gr 210 idrorepellente/PolyMa gr 210 water repellent
T = TexMa gr 190 idrorepellente/TexMa 190 gr water repellent



Art 87Q - cm 250x250

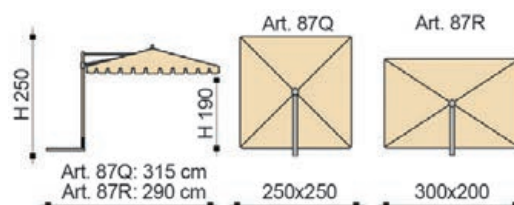



ESCLUSIVO MAFFEI
MAFFEI EXCLUSIVITY



Art. 137R - cm 300x200

Art. 137Q-200 cm 200x200/4

Art. 137Q cm 250x250/4

Art. 137R cm 300x200/4

TESSUTO

- PolyMa poliestere gr 210
- Idrorepellente
- Antimuffa
- Resistenza colori 6+
- Protezione UV 50+
- Laccio di chiusura
- Senza volanti
- Imballo: 1 scatola

FABRIC

- PolyMa Polyester 210 gr
- Water repellent
- Mouldproof
- Colour fastness 6+
- UV protection 50+
- Tie-band for closing
- Without valances
- Packing: 1 carton

TELAIO: ALLUMINIO

vedi pag. 15

Pezzi di ricambio disponibili

FRAME: ALUMINIUM

see pag. 15

Spare parts on demand

Colori / Colours Art 137Q - 137R

Art 137Q-200

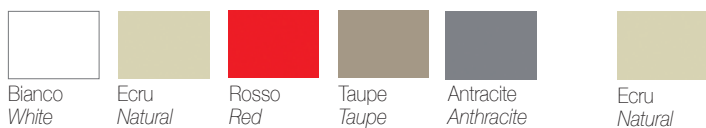

Colori su richiesta / Colours on demand Art 137Q/137R

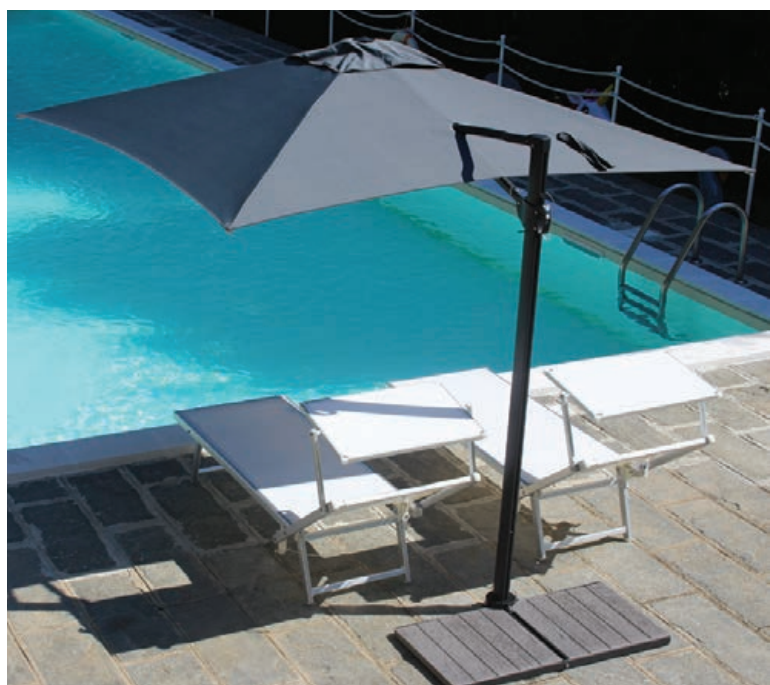

Art 137Q - cm 250x250

T = TexMa gr 190 idrorepellente/TexMa 190 gr water repellent

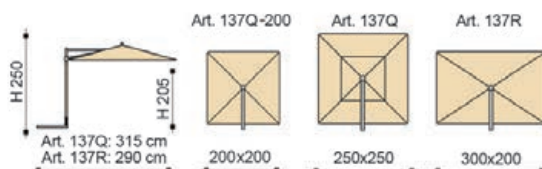



ESCLUSIVO MAFFEI
MAFFEI EXCLUSIVITY



Art. 127R - cm 300x200

Art. 127Q cm 250x250/4
Art. 127R cm 300x200/4

TESSUTO

- Poliestere standard gr 150
- Idrorepellente
- Resistenza colori 4-6
- Laccio di chiusura
- Con volanti
- Imballo: 1 scatola

FABRIC

- Standard polyester 150 gr
- Water repellent
- Colour fastness 4-6
- Tie-band for closing
- With valances
- Packing: 1 carton

TELAIO: ALLUMINIO

vedi pag. 15

Pezzi di ricambio disponibili

FRAME: ALUMINIUM

see pag. 15

Spare parts on demand



Art 127Q - cm 250x250

Colori / Colours



Ecu Natural Grigio Grey

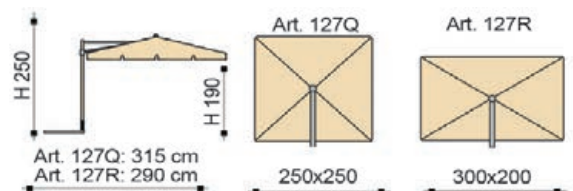

Art. 87Q-R, Art. 137Q-R, Art. 127Q-R

MAFFEI LATO

MAFFEI LATO è il telaio tipico di Maffei. E' molto compatto, facile da usare, leggero ma resistente. La sua caratteristica è **l'apertura senza corde e manovelle**, che lo rendono affidabile nel tempo. Il telaio può ruotare a 360° e funziona perfettamente sia che la base sia messa dietro o davanti al palo. E' retrattile e da chiuso si ritira vicino al palo.

MAFFEI LATO

*MAFFEI LATO is the side pole frame, Maffei's exclusivity. It's very compact, easy handling, not heavy but strong. The opening system is **without ropes nor crank**, so it's very reliable and longlasting. The frame is rotating 360° and can work perfectly both with the base behind that in front of the pole.*

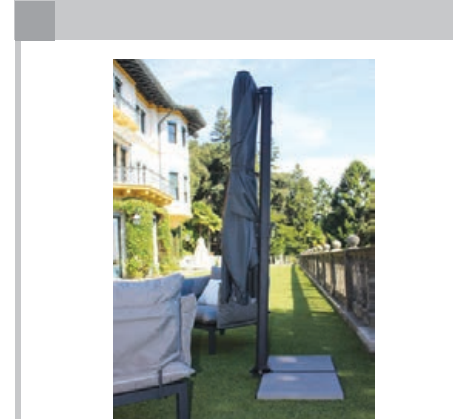

BACCHETTE

Tubolare acciaio con molla apertura.

RIBS

Steel tube with opening spring.

PALI

Alluminio mm 50x78
colore grafite.

POLE

*Alu 50x78 mm
graphite colour.*

APERTURA

Esclusiva con manopola scorrevole senza corde e manovelle.

OPENING

Exclusivity with alu sliding handle, without ropes, nor crank.

BASE

Forma a T, girevole a 360°, può essere messa dietro o davanti al palo.

Opzione: ruote con freno

BASE

T-shaped, rotating 360°, can be placed behind or in front of the pole.

Option: wheels with brake

CONTRAPPESO

> Kg 40

WEIGHT FOR BASE

> 40 Kg

MANOPOLA

In alluminio con fermo di sicurezza.

HANDLE

Aluminium with safety lock.



OPZIONE RUOTE CON FRENO
OPTION WHEELS WITH BRAKE





Art. 137Q-ICE cm 260x260/4

TESSUTO

- PolyMa poliestere gr 210
- Idrorepellente
- Antimuffa
- Resistenza colori 6+
- Protezione UV 50+
- Laccio di chiusura
- Senza volant
- Imballo: 1 scatola

FABRIC

- PolyMa Polyester 210 gr
- Water repellent
- Mouldproof
- Colour fastness 6+
- UV protection 50+
- Tie-band for closing
- Without valances
- Packing: 1 carton

TELAIO: ALLUMINIO

vedi pag. 17

Pezzi di ricambio disponibili

FRAME: ALUMINIUM

see pag. 17

Spare parts on demand

Colori / Colours



Bianco
White

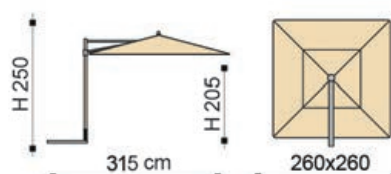

Inclinabile - Tiltable



Girevole 360° - Rotating 360°

Art. 137Q-ICE

KRONOS ICE

MAFFEI LATO ICE è il telaio laterale in colore bianco esclusivo di Maffei. E' molto compatto e facile da usare, leggero e resistente. Ha **l'apertura senza corde, né manovelle**. Il telaio può ruotare a 360° e inclinarsi. La base può essere messa dietro o davanti all'ombrellone.

KRONOS ICE

*MAFFEI LATO ICE is the side pole frame in white colour, Maffei's exclusivity. It's very compact, easy to handle, not heavy, but strong. The **opening system is without ropes, nor crank**. The frame is 360° turnable and is tiltable. The base can stay in front of or behind the pole.*



BACCHETTE

Alluminio colore bianco.

RIBS

Alu ribs, white colour.

PALI

Alluminio mm 50x50 colore bianco.

POLE

Alu 50x50 mm white colour.

APERTURA

Esclusiva con manopola scorrevole senza corde e manovelle.

OPENING

Exclusivity, without rope, nor crank.

BASE

Forma a T, girevole ed inclinabile a 360°.

BASE

Rotating 360°, T-shaped.

INCLINAZIONE

Inclinabile con manopola.

TILTING SYSTEM

Tiltable with handle.

CONTRAPPESO

> Kg 40

WEIGHT FOR BASE

> 40 Kg





Art. 448Q cm 300x300/8

Art. 449R cm 300x400/8

TESSUTO

- PolyMa poliestere gr 210
- Idrorepellente
- Antimuffa
- Resistenza colori 6+
- Protezione UV 50+
- Antivento
- Laccio di chiusura
- Senza volantini
- Imballo: 1 scatola

FABRIC

- PolyMa polyester 210 gr
- Water repellent
- Mouldproof
- Colour fastness 6+
- UV protection 50+
- Air-vent
- Tie-band for closing
- Without valances
- Packaging: 1 carton

MONTURA: ALLUMINIO

Pezzi di ricambio disponibili

FRAME: ALUMINIUM

Spare parts available

Colori / Colours



Ecu
Ecu Taupe
Taupe Antracite
Anthracte

Colori su richiesta / Colours on demand



Bianco
White Giallo
Yellow Arancio
Orange Rosso
Red Verde
Green

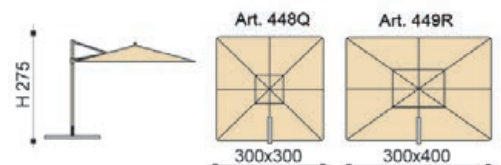

Art. 448Q, Art. 449R

ANTIBES

Antibes è la serie di ombrelloni laterali retrattili basic di Maffei. La struttura è di alluminio, import, ma la tela è prodotta nella nostra fabbrica, in Italia. Anche il tessuto è di produzione italiana e questo vi assicura delle prestazioni superiori come resistenza colore (6+), protezione uv (50+), gamma colori, servizio, disponibilità di ricambi, dando quindi al cliente finale un plusvalore.

ANTIBES

Antibes is the basic line of side folding umbrellas by Maffei. The aluminium frame is imported, while the canvas is made in our factory, in Italy. The fabric is made in Italy too, for a higher sun fastness (6+), UV protection(50+), a wider range of colours and the possibility to change the canvas when needed.



BACCHETTE

Tubo alluminio mm 17x25

RIBS

Alu tube 17x25 mm

PALO

Alluminio mm 54x86 colore grafite

POLE

Alu mm 54x86 graphite colour

APERTURA

Con manopola e manovella

OPENING

By handle + crank

INCLINABILE

A più posizioni

TILTING SYSTEM

Multiposition

BASE

A X girevole 360°, con pedale

BASE

X shaped, 360° rotating, with pedal

PESO PER BASE

Kg 80 min

WEIGHT FOR BASE

80 Kg min

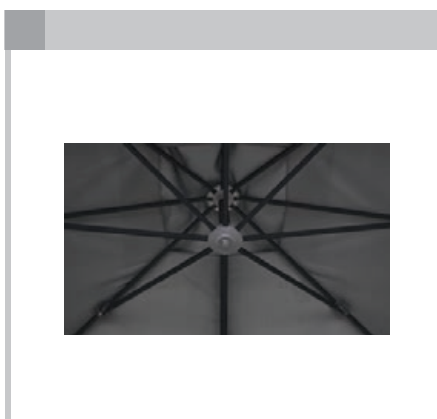

OMBRELLONI GRANDI

La collezione Maffei
soddisfa ogni esigenza di
spazio, coprendo
con eleganza anche
grandi superfici.

LARGE PARASOLS

*Maffei's parasols
are suitable to different types
of space,
they elegantly cover wide
surfaces too.*







Art. 155Q cm 300x300/8

Art. 156R cm 300x400/8

TESSUTO

- PolyMa poliestere gr 210
- Idrorepellente
- Antimuffa
- Resistenza colori 6+
- Protezione UV 50+
- Laccio di chiusura
- Senza volant
- Antivento
- Imballo: 1 scatola

TELAIO: FIBRA DI VETRO

vedi pag. 23

Pezzi di ricambio disponibili

Colori / Colours

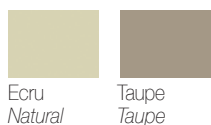

Ecu Natural
Taupe
Taupe

T = TexMa gr 190 idrorepellente/TexMa 190 gr water repellent

Colori su richiesta / Colours on demand



Bianco White
Giallo Yellow
Verde Green
Arancio Orange
Rosso Red
Blu Blue
Antracite Anthracite
Nero Black

FABRIC

- PolyMa Polyester 210 gr
- Water repellent
- Mouldproof
- Colour fastness 6+
- UV protection 50+
- Tie-band for closing
- Without valances
- Air-vent
- Packing: 1 carton

FRAME: FIBERGLASS

see pag. 23

Spare parts on demand

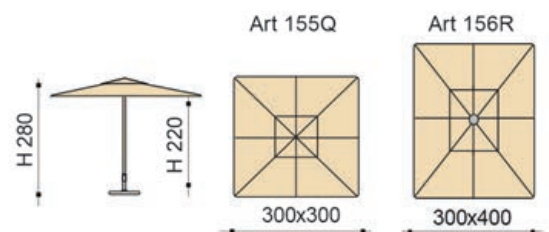

Art. 155Q, Art. 156R

FIBRASOL

FIBRASOL è la serie migliore della produzione Maffei. La struttura in FIBRA DI VETRO conferisce una resistenza ed elasticità uniche, superiori ad una struttura simile in legno o metallo, grazie alla capacità di questo materiale composito, di assorbire le sollecitazioni improvvise.

FIBRASOL

FIBRASOL is the best line manufactured by Maffei. The frame made of FIBERGLASS gives excellent elasticity and strenght, much more than similar products, thanks to this composite material resistance to sudden stress.

BACCHETTE

Fibra di vetro intercambiabili.
Colore teak.

RIBS

*Fiberglass exchangeable.
Teak colour.*

APERTURA

Con carrucola doppia.

OPENING

With double pulley.

TAMPUS

Gigante a pigna.

TOP

Giant, pine cone shaped.

VITI

In acciaio inox.

SCREWS

Stainless steel.

PALO

Fibra di vetro mm 48
colore teak.

POLE

*Fiberglass 48 mm
teak colour.*

CONTRAPPESO

> Kg 35

WEIGHT FOR BASE

> 35 Kg





Art. 175Q cm 300x300/8

Art. 176R cm 300x400/8

TESSUTO

- PolyMa poliestere gr 210
- Idrorepellente
- Antimuffa
- Resistenza colori 6+
- Protezione UV 50+
- Laccio di chiusura
- Senza volanti
- Antivento
- Imballo: 1 scatola

TELAIO: FIBRA DI VETRO

vedi pag. 25

Pezzi di ricambio disponibili

FABRIC

- PolyMa Polyester 210 gr
- Water repellent
- Mouldproof
- Colour fastness 6+
- UV protection 50+
- Tie-band for closing
- Without valances
- Air-vent
- Packing: 1 carton

FRAME: FIBERGLASS

see pag. 25

Spare parts on demand

Colori / Colours



Ecu
Natural

Taupe
Taupe

T = TexMa gr 190 idrorepellente/ TexMa 190 gr water repellent

Colori su richiesta / Colours on demand



Bianco
White

Giallo
Yellow

Verde
Green

Arancio
Orange

Rosso
Red

Blu
Blue

Antracite
Anthracite

Nero
Black

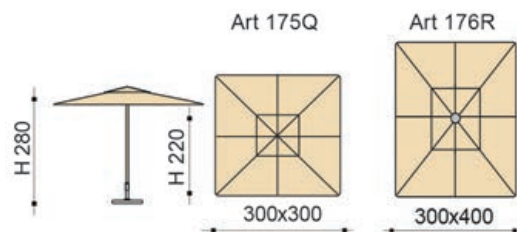

Art. 175Q, Art. 176R

FIBRASOL

FIBRASOL è la serie migliore della produzione Maffei. La struttura in FIBRA DI VETRO conferisce una resistenza ed elasticità uniche, superiori ad una struttura simile in legno o metallo, grazie alla capacità di questo materiale composito, di assorbire le sollecitazioni improvvise.

FIBRASOL

FIBRASOL is the best line manufactured by Maffei. The frame made of FIBERGLASS gives excellent elasticity and strenght, much more than similar products, thanks to this composite material resistance to sudden stress.

BACCHETTE

Fibra di vetro intercambiabili.

RIBS

Fiberglass exchangeable.

APERTURA

Con carrucola doppia.

OPENING

With double pulley.

TAMPUS

Gigante a pigna.

TOP

Giant, pine cone shaped.

VITI

In acciaio inox.

SCREWS

Stainless steel.

PALO

Fibra di vetro mm 48
colore argento.

POLE

*Fiberglass 48 mm
silver colour.*

CONTRAPPESO

> Kg 35

WEIGHT FOR BASE

> 35 Kg





Art. 152R cm 200x300/6 **Art. 153Q** cm 300x300/8
Art. 154R cm 300x400/8 **Art. 154-4** cm 400x400/8

TESSUTO

- PolyMa poliestere gr 210
- Idrorepellente
- Antimuffa
- Resistenza colori 6+
- Protezione UV 50+
- Antivento
- Laccio di chiusura
- Senza volantini*
- Imballo: 1 scatola

TELAIO: LEGNO

vedi pag. 27

Pezzi di ricambio disponibili

FABRIC

- PolyMa Polyester 210 gr
- Water repellent
- Mouldproof
- Colour fastness 6+
- UV protection 50+
- Air-vent
- Tie-band for closing
- Without valances*
- Packing: 1 carton

FRAME: WOOD

see pag. 27

Spare parts on demand



*Con volante su richiesta - With flaps on demand

Colori / Colours



Colore / Colour Art. 154-4

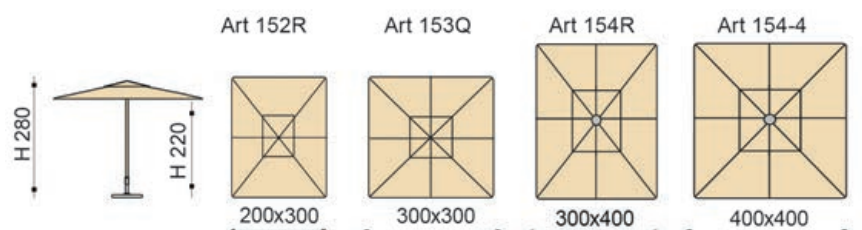
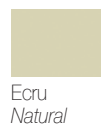

Art. 152R, Art. 153Q, Art. 154R, Art. 154-4

TIMBERS

TIMBERS è la serie di ombrelloni in legno di Maffei. Il palo in legno ha doppia verniciatura trasparente, le finiture interne sono tipo "vintage", le stecche sono smontabili, il legno è di qualità molto buona. Tutti questi particolari distinguono il nostro prodotto dagli altri sul mercato.

TIMBERS

TIMBERS is Maffei's line of wooden parasols. The pole is wood, with double transparent coating and the runner has vintage style. The ribs are exchangeable and the wood is of very good quality. For all these reasons our item is different from the other on the market.

BACCHETTE

Legno intercambiabili.

RIBS

Wood, exchangeable.

APERTURA

Con carrucola.

OPENING

With pulley.

ACCESSORI

Collano e tampos in legno giganti.

ACCESSORIES

Giant wood runner and top.

VITI

In acciaio galvanizzato.

SCREWS

Galvanized steel screws.

PALO

Legno mm 48 con doppia verniciatura trasparente.

POLE

Wood 48 mm with double transparent painting.

CONTRAPPESO

> Kg 35

WEIGHT FOR BASE

> 35 Kg

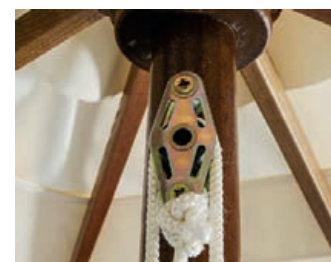



Art. 139Q cm 300x300/8

Art. 140R cm 300x400/8

Art. 141Q cm 400x400/8

TESSUTO

- PolyMa poliestere gr 210
- Idrorepellente
- Antimuffa
- Resistenza colori 6+
- Protezione UV 50+
- Antivento
- Laccio di chiusura
- Senza volantini
- Imballo: 1 scatola

FABRIC

- PolyMa Polyester 210 gr
- Water repellent
- Mouldproof
- Colour fastness 6+
- UV protection 50+
- Air-vent
- Tie-band for closing
- Without valances
- Packing: 1 carton

TELAIO: ALLUMINIO TELESCOPICO

vedi pag. 29

Pezzi di ricambio disponibili

FRAME: ALUMINIUM TELESCOPIC

see pag. 29

Spare parts on demand

Colori / Colours



Ecu Natural Taupe Taupe Antracite Anthracite

Colori su richiesta / Colours on demand Art. 139Q-140R



Bianco White Giallo Yellow Arancio Orange Rosso Red Verde Green Blu Blue

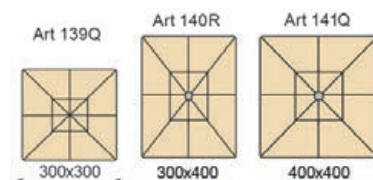
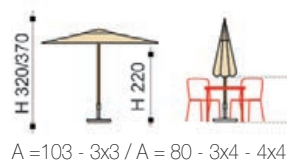
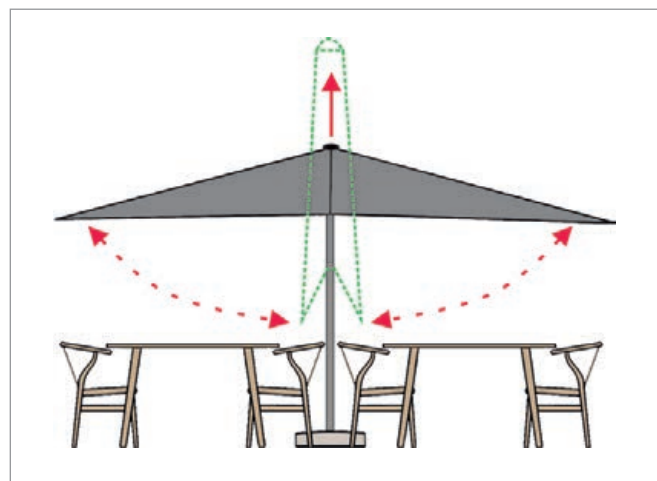

Art. 139Q, 140R, 141Q

MAFFEI TE

MAFFEI TE è la struttura telescopica di Maffei. Il sistema d'apertura con maniglia è leggero e resistente. Occorre solo spingere la maniglia verso l'alto. L'ombrellone, da chiuso, resta più in alto del tavolo sottostante. E' un ombrellone grande, molto semplice da usare. La struttura è in alluminio, colore antracite e le bacchette sono smontabili.

MAFFEI TE

MAFFEI TE is the telescopic frame by Maffei. The opening system with handle is light and strong. The handle has to be pushed up. The parasol, when closed, stays above the table, without touching it. This parasol is big but easy to use. The frame is alu, anthracite colour, and exchangeable ribs.

BACCHETTE

Alluminio mm 19x29 intercambiabili.

RIBS

Aluminium mm19x29 exchangeable.

PALO

Alluminio mm 60 colore grafite, telescopico.

POLE

Aluminium 60 mm colour graphite, telescopic.

APERTURA

Con maniglia.

OPENING

By handle.

TELAIO

Telescopico: chiudendo si alza.

FRAME

Telescopic: the umbrella goes up when it is closed.

PESO PER BASE

Cm 300x300 min kg 35

Cm 300x400-400x400 min kg 50

WEIGHT FOR BASE

300x300 cm min 35 Kg

300x400-400x400 cm min 50 Kg





Art. 66 cm 140/6 – D 280

TESSUTO

- PolyMa poliestere gr 210
- Idrorepellente
- Antimuffa
- Resistenza colori 6+
- Protezione UV 50+
- Senza volanti
- Imballo: scatola x 1

TELAIO: ALLUMINIO EFFETTO LEGNO

- **Palo:** alluminio mm 35/40, finitura legno, altezza regolabile, senza snodo
- **Bacchette:** paragon marroni
- **Accessori:** tipo de-luxe marroni
- **Peso** per base **Kg** > Kg 30

Pezzi di ricambio disponibili

FABRIC

- PolyMa Polyester 210 gr
- Water repellent
- Mouldproof
- Colour fastness 6+
- UV protection 50+
- Without valances
- Packing: carton x 1

FRAME: WOOD EFFECT ALUMINIUM

- **Pole:** alu 35/40 mm wood finish, adjustable height, without tilt
- **Ribs:** paragon, brown
- **Accessories:** Type de-luxe brown
- **Weight** for base **Kg** > 30 Kg

Spare parts on demand



Colori / Colours

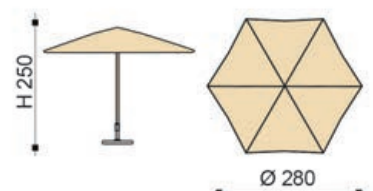



Art. 66Q cm 200x200/4

Art. 66R cm 240x150/4

TESSUTO

- PolyMa poliestere gr 210
- Idrorepellente
- Antimuffa
- Resistenza colori 6+
- Protezione UV 50+
- Senza volantini
- Imballo: scatola x 1

TELAIO: ALLUMINIO EFFETTO LEGNO

- **Palo:** alluminio mm 35/40, finitura legno, altezza regolabile, senza snodo
- **Bacchette:** paragon marroni
- **Accessori:** tipo De-Luxe marroni
- **Peso** per base > Kg 25

Pezzi di ricambio disponibili

FABRIC

- PolyMa Polyester 210 gr
- Water repellent
- Mouldproof
- Colour fastness 6+,
- UV protection 50+
- Without valances
- Packing: carton x 1

FRAME: WOOD EFFECT ALUMINIUM

- **Pole:** alu 35/40 mm wood finish, adjustable height, without tilt
- **Ribs:** paragon, brown
- **Accessories:** Type de-luxe brown
- **Weight** for base > 25 Kg

Spare parts on demand

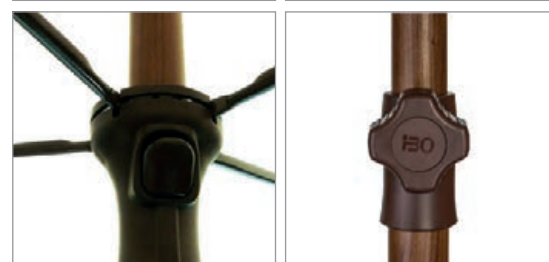

Colori / Colours

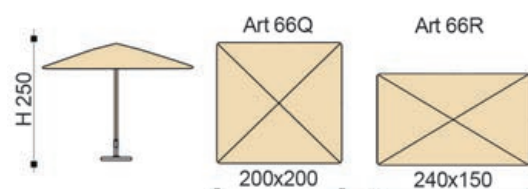

OMBRELLONI DI DESIGN

Gli ombrelloni Maffei
si distinguono per il loro design
esclusivo o registrato,
questo permette di rendere unico
ed inconfondibile
il vostro ambiente.

DESIGN PARASOLS

*Maffei's exclusive
or patented design
will make your space
distinctive and unique.*

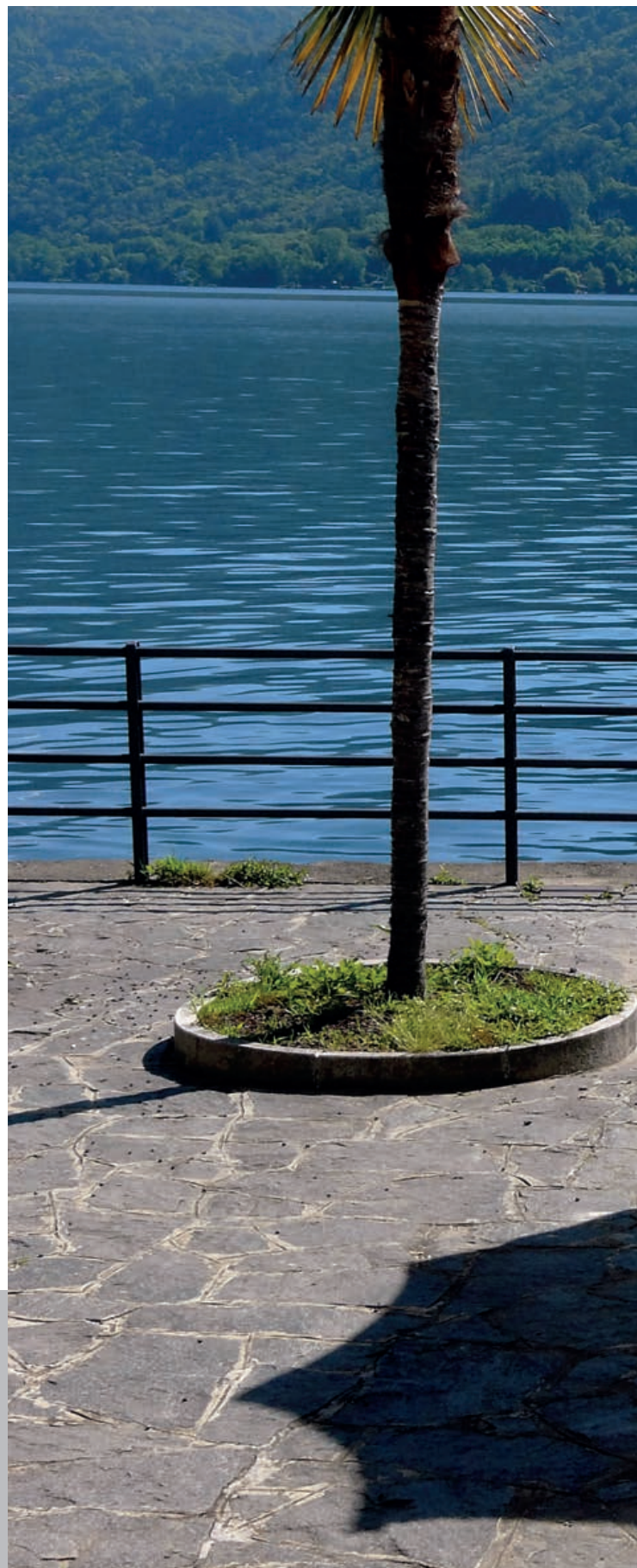



ESCLUSIVO MAFFEI
MAFFEI EXCLUSIVITY



Bianco
White

Ecru
Natural

Antracite
Anthracite

Taupe
Taupe

Bianco int.
White int.

Ecru int.
Natural int.

Antracite int.
Anthracite int.

Taupe int.
Taupe int.

Art. 28 cm 125/10 – D 250

TESSUTO

- PolyMa poliestere gr 210
- Idrorepellente
- Antimuffa
- Resistenza colori 6+
- Protezione UV 50+
- Ricamo a fiore sulla punta
- In dotazione antivento in Kristal per la pioggia*
- Imballo: scatole x 1

TELAIO

- **Palo:** acciaio mm 27/30 bianco, altezza regolabile, snodo metallo
 - **Bacchette:** acciaio bianche
 - **Accessori:** serie de-luxe bianca
 - **Peso** per base **Kg** > Kg 25
- SU RICHIESTA:
montura palo alluminio mm 35/40
- Pezzi di ricambio disponibili

FABRIC

- PolyMa Polyester 210 gr
- Water repellent
- Mouldproof
- Colour fastness 6+
- UV protection 50+
- Flower shaped embroidery near the top
- Kristal air-vent for rain*
- Packing: cartons x 1

FRAME

- **Pole:** steel 27/30 mm, white colour, adjustable height, with metal tilt
 - **Ribs:** steel, white colour
 - **Accessories:** type de-luxe, white
 - **Weight** for base **Kg** > 25 Kg
- ON DEMAND:
frame with alu pole 35/40 mm
- Spare parts on demand

Colori / Colours

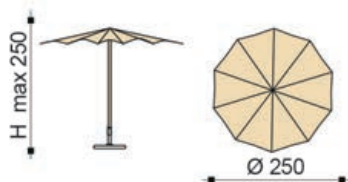

ESCLUSIVO MAFFEI
MAFFEI EXCLUSIVITY



Art. 27 cm 100/10 – D 200

Art. 29 cm 140/10 – D 280

TESSUTO

- PolyMa poliestere gr 210
- Idrorepellente
- Antimuffa
- Resistenza colori 6+
- Protezione UV 50+
- Ricamo a fiore sulla punta
- In dotazione antivento in Kristal per la pioggia*
- Imballo: scatole x 1

FABRIC

- PolyMa Polyester 210 gr
- Water repellent
- Mouldproof
- Colour fastness 6+
- UV protection 50+
- Flower shaped embroidery near the top
- Kristal air-vent for rain*
- Packing: cartons x 1

TELAIO

- **Palo:** acciaio mm 27/30 grafite, altezza regolabile, snodo metallo
- **Bacchette:** acciaio grafite
- **Accessori:** serie de-luxe grafite
- **Peso** per base **Kg** > Kg 15 Art. 27
> Kg 30 Art. 29

FRAME

- **Pole:** steel 27/30 mm, graphite colour, adjustable height, with metal tilt
- **Ribs:** steel, noir graphite
- **Accessories:** type de-luxe, graphite
- **Weight** for base **Kg** > 15 Kg for Art. 27
> 30 Kg for Art. 29

Pezzi di ricambio disponibili

Spare parts on demand

Colori / Colours

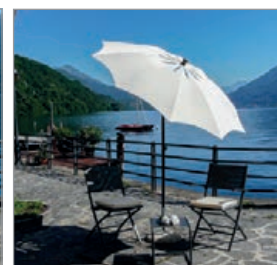
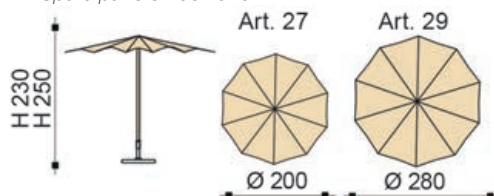
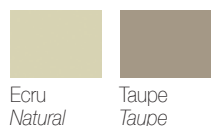

ESCLUSIVO MAFFEI
MAFFEI EXCLUSIVITY



Art. 86R cm 240x150/4

TESSUTO

- Tessuto gr 190/210
(vedere dettagli su schema colori)
- Resistenza colore 5-7
- Protezione UV 50+
- Con volanti Allegro
- Imballo: scatole x 1

TELAIO

- **Palo:** acciaio mm 27/30 grafite, altezza regolabile, snodo metallo
- **Bacchette:** paragon grafite
- **Accessori:** serie de-luxe grafite
- **Peso per base** > Kg 25

Pezzi di ricambio disponibili

FABRIC

- *Fabric 190/210 gr
(see details on colour scheme)*
- *Colour fastness 5-7*
- *UV protection 50+*
- *With valances Allegro*
- *Packing: cartons x 1*

FRAME

- *Pole: steel 27/30 mm, graphite, adjustable height, with metal tilt*
- *Ribs: paragon, graphite colour*
- *Accessories: type de-luxe, graphite*
- *Weight for base* > 25 Kg

Spare parts on demand



Colori / Colours

P	P	T	P	T	P	T
Ecrù <i>Natural</i>	Taupe <i>Taupe</i>	Terracotta <i>Terracotta</i>	Verde <i>Green</i>	Lime <i>Lime</i>	Blu <i>Blue</i>	Turchese <i>Turquoise</i>

P = PolyMa gr 210 idrorepellente/*PolyMa 210 gr water repellent*
T = TexMa gr 190 idrorepellente/*TexMa 190 gr water repellent*

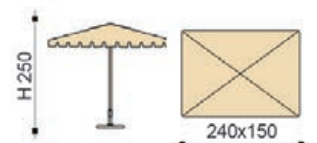

**ESCLUSIVO MAFFEI
MAFFEI EXCLUSIVITY**



Art. 84 cm 100/10 – D 200 Art. 85 cm 140/10 – D 280

TESSUTO

- Tessuto gr 190/210
(vedere dettagli su schema colori)
- Resistenza colore 5-7
- Protezione UV 50+
- Con volanti Allegro
- Imballo: scatole x 5 art. 84 - x 1 art. 85

TELAIO

- **Palo:** acciaio mm 27/30 grafite, altezza regolabile, snodo metallo
- **Bacchette:** acciaio grafite
- **Accessori:** serie de-luxe grafite
- **Peso** per base **Kg** > Kg 15 Art. 84
> Kg 30 Art. 85

FABRIC

- *Fabric 190/210 gr*
(see details on colour scheme)
- *Colour fastness 5-7*
- *UV protection 50+*
- *With valances Allegro*
- *Packing: cartons x 5 art. 84 - x 1 art. 85*

FRAME

- **Pole:** steel 27/30 mm, graphite colour, adjustable height, with metal tilt
- **Ribs:** steel, graphite colour
- **Accessories:** type de-luxe, graphite
- **Weight** for base **Kg** > 15 Kg Art. 84
> 30 Kg Art. 85

Pezzi di ricambio disponibili

Spare parts on demand

Colori / Colours Art. 84



Colori / Colours Art. 85

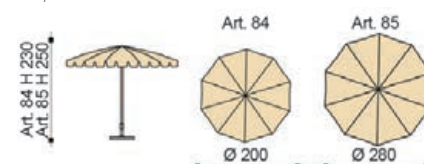
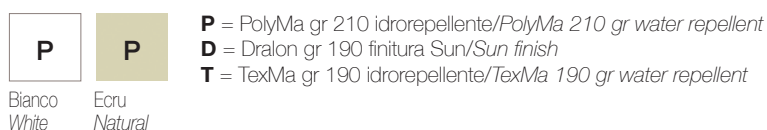

ESCLUSIVO MAFFEI
MAFFEI EXCLUSIVITY



Art. 44BR cm 210x130/4

Art. 46BQ cm 200x200/4

TESSUTO

- Dralon gr 190 finitura sun
- Resistenza colore 5-7
- Protezione UV 20-50+
- Senza volantì
- Cucitura esterna con bordo grigio scuro
- Imballo: scatole x 1

TELAIO

- **Palo:** acciaio mm 27/30 grafite, altezza regolabile, snodo metallo
- **Bacchette:** paragon grafite
- **Accessori:** serie de-luxe grafite
- **Peso per base** > Kg 25

Pezzi di ricambio disponibili

FABRIC

- *Dralon 190 gr Sun finish*
- *Colour fastness 5-7*
- *UV protection 20-50+*
- *Without valances*
- *Outside seam with dark grey band*
- *Packing: cartons x 1*

FRAME

- **Pole:** steel 27/30 mm, graphite colour, adjustable height, with metal tilt
- **Ribs:** paragon graphite colour
- **Accessories:** type de-luxe, graphite
- **Weight for base** > 25 Kg

Spare parts on demand

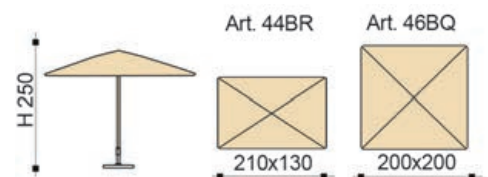

Colori / Colours Art. 44BR



Colori / Colours Art. 46BQ

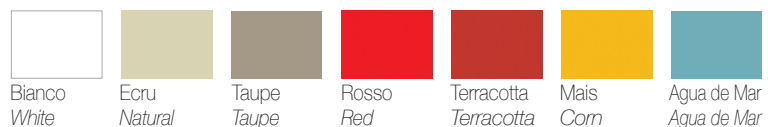

ESCLUSIVO MAFFEI
MAFFEI EXCLUSIVITY



Art. 42B cm 100/10 – D 200

Art. 45B cm 140/10 – D 280

TESSUTO

- Dralon gr 190 finitura sun
- Resistenza colore 5-7
- Protezione UV 20-50+
- Senza volantini
- Cucitura esterna con bordo grigio scuro
- Imballo: scatole x 5 art. 42B
x 1 art. 45B

TELAIO

- **Palo:** acciaio mm 27/30 grafite, altezza regolabile, snodo metallo
- **Bacchette:** acciaio grafite
- **Accessori:** serie de-luxe grafite
- **Peso** per base **Kg** > Kg 15 Art. 42B
> Kg 30 Art. 45B

Pezzi di ricambio disponibili

FABRIC

- *Dralon 190 gr Sun finish*
- *Colour fastness 5-7*
- *UV protection 20-50+*
- *Without valances*
- *Outside seam with dark grey band*
- *Packing: cartons x 5 art. 42B
x 1 art. 45B*

FRAME

- *Pole: steel 27/30 mm, graphite colour, adjustable height, with metal tilt*
- *Ribs: steel, graphite colour*
- *Accessories: type de-luxe, grafite*
- *Weight for base Kg* > 15 Kg Art. 42B
> 30 Kg Art. 45B

Spare parts on demand

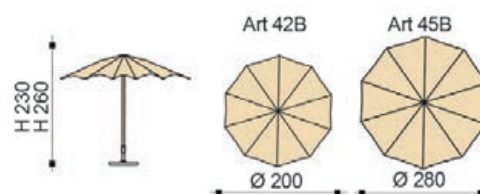

Colori / Colours Art. 42B

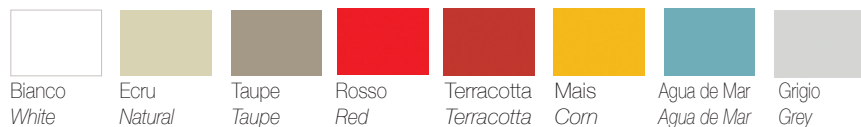

Colori / Colours Art. 45B



ESCLUSIVO MAFFEI
MAFFEI EXCLUSIVITY



Art. 55 cm 125/10 – D 250

TESSUTO

- PolyMa poliestere gr 210
- Idrorepellente
- Antimuffa
- Resistenza colori 6+
- Protezione UV 50+
- Senza volanti
- Forma piatta a stella
- Imballo: scatole x 1

TELAIO

- **Palo:** acciaio mm 27/30, grafite, altezza regolabile, con snodo metallo
- **Bacchette:** paragon grafite
- **Accessori:** serie de-luxe grafite
- **Peso** per base **Kg** > Kg 25

Pezzi di ricambio disponibili

FABRIC

- PolyMa Polyester 210 gr
- Water repellent
- Mouldproof
- Colour fastness 6+,
- UV protection 50+
- Without valances
- Flat star shaped
- Packing: cartons x 1

FRAME

- **Pole:** steel 27/30 mm, graphite, adjustable height, with metal tilt
- **Ribs:** paragon, graphite
- **Accessories:** type de-luxe graphite
- **Weight** for base **Kg** > 25 Kg

Spare parts on demand

Colori / Colours



ESCLUSIVO MAFFEI
MAFFEI EXCLUSIVITY



Art. 56 cm 125/10 – D 250

TESSUTO

- Dralon gr 190 finitura Sun
- Resistenza colore 5-7
- Protezione UV 20-50+
- Senza volantini
- Forma piatta a stella
- Laccio di chiusura
- Imballo: scatole x 1

TELAIO

- **Palo:** acciaio mm 27/30 grafite, altezza regolabile, snodo metallo
- **Bacchette:** paragon grafite
- **Accessori:** serie de-luxe grafite
- **Peso** per base > Kg 25

Pezzi di ricambio disponibili

FABRIC

- *Dralon 190 gr Sun finish*
- *Colour fastness 5-7*
- *UV protection 20-50+*
- *Without valances*
- *Flat star shape*
- *Tie-band for closing*
- *Packing: cartons x 1*

FRAME

- **Pole:** steel 27/30 mm, graphite colour, adjustable height, with metal tilt
- **Ribs:** paragon graphite colour
- **Accessories:** type de-luxe, graphite
- **Weight** for base > 25 Kg

Spare parts on demand



Colori / Colours

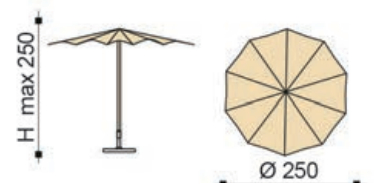
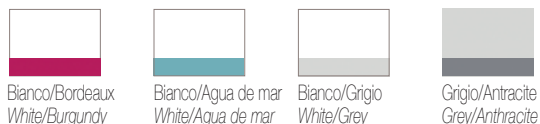

ESCLUSIVO MAFFEI
MAFFEI EXCLUSIVITY



Art. 18 cm 100/8 SQ – D 200 SQ

TESSUTO

- Tessuto gr 190/210
(vedere dettagli su schema colori)
- Idrorepellente
- Antimuffa
- Resistenza colore 6+/7
- Protezione UV 50+
- Forma semiquadra
- Imballo: scatole x 5

TELAIO

- **Palo:** acciaio mm 27/30 bianco, altezza regolabile, snodo in metallo
- **Bacchette:** acciaio mm 3,80 bianche
- **Accessori:** serie lusso bianca
- **Peso** per base  > Kg 15

Pezzi di ricambio disponibili

FABRIC

- Fabric 190/210 gr
(see details on colour scheme)
- Water repellent
- Mouldproof
- Colour fastness 6+/7
- UV protection 50+
- Half-square shape
- Packing: cartons x 5

FRAME

- **Pole:** Pole: steel 27/30 mm white, adjustable height, with metal tilt
- **Ribs:** steel 3,80 mm white
- **Accessories:** de-luxe white
- **Weight** for base  > 15 Kg

Spare parts on demand

P = PolyMa gr 210 idrorepellente/PolyMa 210 gr water repellent

T = TexMa gr 190 idrorepellente/TexMa 190 gr water repellent



Colori / Colours

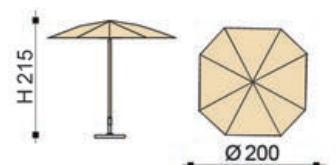



Art. 138Q cm 225x225/8

TESSUTO

- PolyMa poliestere gr 210
- Idrorepellente
- Antimuffa
- Resistenza colori 6+
- Protezione UV 50+
- Laccio di chiusura
- Senza volant
- Imballo: scatole x 1

TELAIO

- **Palo:** alluminio mm 40, bianco, unico, senza snodo
- **Bacchette:** alluminio bianche
- **Accessori:** bianchi
- **Peso** per base **Kg** > Kg 30

Pezzi di ricambio disponibili

FABRIC

- PolyMa Polyester 210 gr
- Water repellent
- Mouldproof
- Colour fastness 6+
- UV protection 50+
- Tie-band for closing
- Without valances
- Packing: cartons x 1

FRAME

- **Pole:** 1-pcs aluminium 40 mm white, without tilt
- **Ribs:** aluminium white
- **Accessories:** white
- **Weight** for base **Kg** > 30 Kg

Spare parts on demand



Colori / Colours

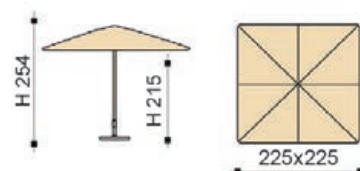
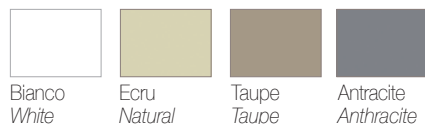



Art. 138R cm 300x200/6

TESSUTO

- PolyMa poliestere gr 210
- Idrorepellente
- Antimuffa
- Resistenza colori 6+
- Protezione UV 50+
- Laccio di chiusura
- Senza volant
- Imballo: scatole x 1

TELAIO

- **Palo:** alluminio mm 38/35 colore grafite, altezza regolabile, con snodo metallo 2 posizioni
- **Bacchette:** acciaio grafite mm 13x19
- **Accessori:** lusso
- **Peso per base** **Kg** > Kg 30

Pezzi di ricambio disponibili

FABRIC

- PolyMa Polyester 210 gr
- Water repellent
- Mouldproof
- Colour fastness 6+
- UV protection 50+
- Tie-band for closing
- Without valances
- Packing: cartons x 1

FRAME

- **Pole:** aluminium 38/35 mm colour graphite, adjustable height, with metal tilt (2 positions)
- **Ribs:** steel 13x19 mm graphite
- **Accessories:** de-luxe
- **Weight for base** **Kg** > 30 Kg

Spare parts on demand

Colori / Colours

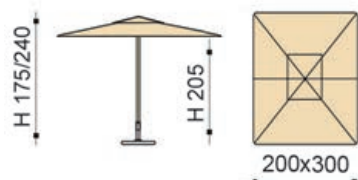



Art. 136Q cm 200x200/4

Art. 136R cm 240x150/4

TESSUTO

- PolyMa poliestere gr 210
- Idrorepellente
- Antimuffa
- Resistenza colori 6+
- Protezione UV 50+
- Senza volantini
- Imballo: scatole x 1

FABRIC

- PolyMa Polyester 210 gr
- Water repellent
- Mouldproof
- Colour fastness 6+
- UV protection 50+
- Without valances
- Packing: cartons x 1

TELAIO

- **Palo:** acciaio mm 27/30 grafite, altezza regolabile, snodo metallo
- **Bacchette:** paragon grafite
- **Accessori:** serie de-luxe grafite
- **Peso** per base > Kg 25

FRAME

- **Pole:** steel 27/30 mm, graphite colour, adjustable height, with metal tilt
- **Ribs:** paragon, graphite colour
- **Accessories:** type de-luxe, graphite
- **Weight** for base > 25 Kg

Pezzi di ricambio disponibili

Spare parts on demand

Colori / Colours

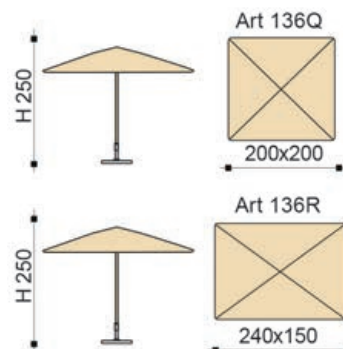
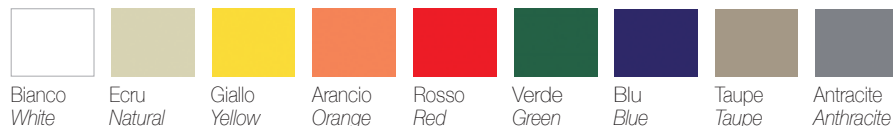



Art. 135/6 cm 125/6 – D 250

TESSUTO

- PolyMa poliestere gr 210
- Idrorepellente
- Antimuffa
- Resistenza colori 6+
- Protezione UV 50+
- Senza volantini
- Imballo: scatole x 5

TELAIO

- **Palo:** acciaio mm 27/30 grafite, altezza regolabile, snodo metallo
- **Bacchette:** paragon grafite
- **Accessori:** serie de-luxe grafite
- **Peso per base**  > Kg 25

Pezzi di ricambio disponibili

FABRIC

- PolyMa Polyester 210 gr
- Water repellent
- Mouldproof
- Colour fastness 6+
- UV protection 50+
- Without valances
- Packing: cartons x 5

FRAME

- **Pole:** steel 27/30 mm, graphite colour, adjustable height, with metal tilt
- **Ribs:** paragon, graphite colour
- **Accessories:** type de-luxe, graphite
- **Weight for base**  > 25 Kg

Spare parts on demand

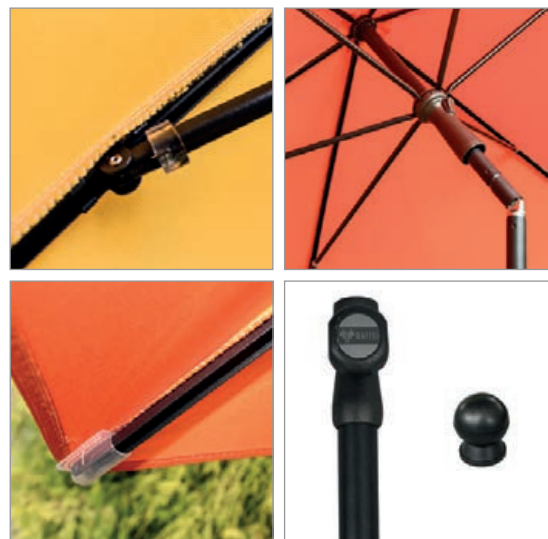

Colori / Colours

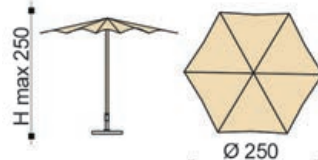



Art. 134 cm 100/10 – D 200

TESSUTO

- PolyMa poliestere gr 210
- Idrorepellente
- Antimuffa
- Resistenza colori 6+
- Protezione UV 50+
- Senza volantini
- Imballo: scatole x 5

TELAIO

- **Palo:** acciaio mm 27/30 grafite, altezza regolabile, snodo metallo, prolungo zincato
- **Bacchette:** acciaio mm 3,80
- **Accessori:** serie de-luxe grafite
- **Peso** per base **Kg** > Kg 15

Pezzi di ricambio disponibili

FABRIC

- PolyMa polyester 210 gr
- Water repellent
- Mouldproof
- Colour fastness 6+
- UV protection 50+
- Without valances
- Packing: cartons x 5

FRAME

- **Pole:** steel 27/30 mm graphite, adjustable height, with metal tilt, galvanised lower pole
- **Ribs:** steel 3,80 mm
- **Accessories:** de-luxe graphite
- **Weight** for base **Kg** > 15 Kg

Spare parts on demand



Colori / Colours





Art 175

Art. 172 cm 100/8 – D 200

Art. 175 cm 150/10 – D 300

TESSUTO

- PolyMa poliestere gr 210
- Idrorepellente
- Antimuffa
- Resistenza colori 6+
- Protezione UV 50+
- Laccio di chiusura
- Con valance e senza antivento su art 172
- Senza valance e con antivento su art 175
- Imballo: scatole x 4 per Art 172
scatole x 1 per Art 175

FABRIC

- PolyMa Polyester 210 gr
- Water repellent
- Mouldproof
- Colour fastness 6+
- UV protection 50+
- Tie-band for closing
- With valances, without air-vent for Art 172
- Without valances, with air-vent for Art 175
- Packing: cartons x 4 – Art 172
cartons x 1 – Art 175

TELAIO > vedi pag. 49

Pezzi di ricambio disponibili

FRAME > see pag. 49

Spare parts on demand

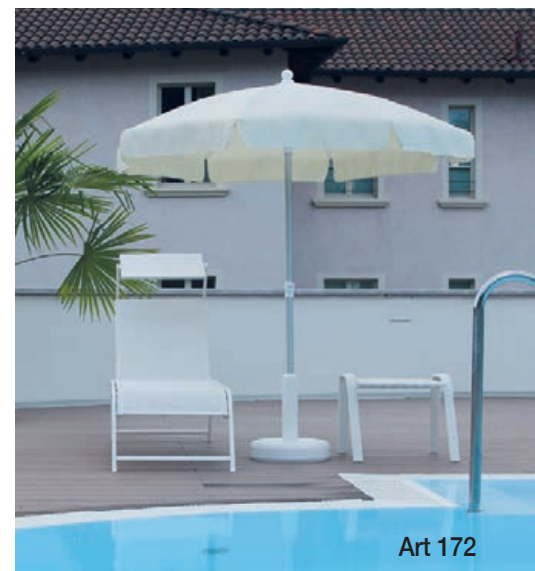

Art 172

Colori / Colours Art. 172



Colori / Colours Art. 175

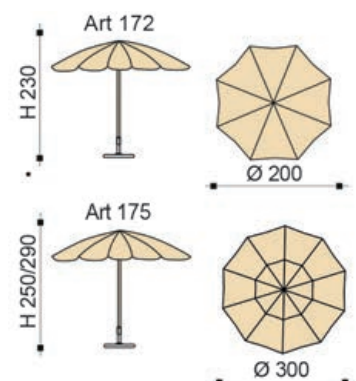

FIBRASOL

FIBRASOL è la serie migliore della produzione Maffei. La struttura in FIBRA DI VETRO conferisce una resistenza ed elasticità uniche, superiori ad una struttura simile in legno o metallo, grazie alla capacità di questo materiale composito, di assorbire le sollecitazioni improvvise.

FIBRASOL

FIBRASOL is the best line manufactured by Maffei. The frame made of FIBERGLASS gives excellent elasticity and strenght, much more than similar products, thanks to this composite material resistance to sudden stress.

BACCHETTE

Fibra di vetro bianca mm 8.

RIBS

Fiberglass mm 8 white colour.

PALO

Alluminio mm 35/40, finitura rigata, altezza regolabile, senza snodo.

POLE

Anodized alu 35/40 mm, adjustable height, without tilt.

IMPUGNATURA

Ergonomica.

RUNNER

Ergonomic.

ACCESSORI

Serie de-luxe bianca con plastiche ad alta resistenza.

ACCESSORIES

Type de-luxe white colour with high density plastic.

PROLUNGO

Con vite.

BOTTOM POLE

With screw.

CONTRAPPESO

> kg 20 per Art 172
> kg 30 per Art 175

WEIGHT FOR BASE

> 20 Kg for Art 172
> 30 Kg for Art 175

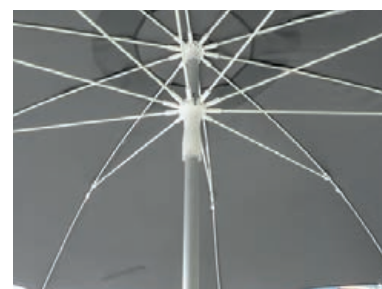



Art 106QSA



Art 106RSA

Art. 106QSA cm 200x200/4

Art. 106RSA cm 240x150/4

TESSUTO

- Polima poliestere gr 210
- Idrorepellente, antimuffa
- Protezione UV 50+
- Resistenza colori 6+
- Laccio di chiusura
- Imballo: scatole x 1

TELAIO

- **Palo:** alluminio mm 35/40, finitura rigata, altezza regolabile, senza snodo
- **Bacchette:** paragon temprato colore bianco
- **Accessori:** serie de-luxe bianca
- **Peso** per base **Kg** > Kg 35

Pezzi di ricambio disponibili

FABRIC

- Polyma polyester 210 gr
- Water repellent, mouldproof
- UV protection 50+
- Colours fastness 6+
- Tie-band for closing
- Packing: carton x 1

FRAME

- **Pole:** anodized alu 35/40 mm, adjustable height, without tilt
- **Ribs:** paragon tempered, white colour
- **Accessories:** type de-luxe white
- **Weight** for base **Kg** > 35 Kg

Spare parts on demand



Colori / Colours

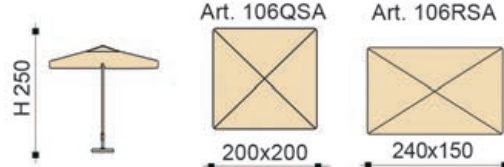



Art. 102SA cm 100/8 – D200

TESSUTO

- Tessuto gr 190/210
(vedere dettagli su schema colori)
- Resistenza colore 5-7
- Protezione UV 20-50+
- Laccio di chiusura
- Imballo: scatole x 5

TELAIO

- **Palo:** alluminio mm 35/40, finitura rigata, altezza regolabile, senza snodo
- **Bacchette:** acciaio zincato mm 4,50 colore bianco
- **Accessori:** serie de-luxe bianca
- **Peso** per base **Kg** > Kg 25

FABRIC

- *Fabric 190/210 gr
(see details on colour scheme)*
- *Colour fastness 5-7*
- *UV protection 20-50+*
- *Tie-band for closing*
- *Packing: cartons x 5*

FRAME

- **Pole:** anodized alu 35/40 mm, adjustable height, without tilt
- **Ribs:** galvanised steel 4,50 mm white colour
- **Accessories:** type de-luxe white
- **Weight** for base **Kg** > 25 Kg

Pezzi di ricambio disponibili

Colori / Colours



D = Dralon gr 190 finitura Sun/Sun finish
T = TexMa gr 190 idrorepellente/ TexMa 190 gr water repellent

Colori speciali / Special colours

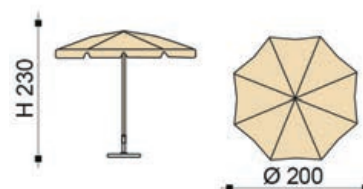



Art. 92 cm 100/10 – D 200

TESSUTO

- Dralon gr 190 finitura sun
- Resistenza colore 5-7
- Protezione UV 20-50+
- Laccio di chiusura
- Con volant
- Imballo: scatole x 5

FABRIC

- Dralon 190 gr sun finish
- Colour fastness 5-7
- UV protection 20-50+
- Tie-band for closing
- With valances
- Packing: cartons x 5

TELAIO

- **Palo:** acciaio inox mm 27/30, altezza regolabile, con snodo
- **Bacchette:** acciaio zincate mm 4,50 verniciate grigie
- **Accessori:** serie de-luxe grigio
- **Peso** per base **Kg** > Kg 20

FRAME

- **Pole:** stainless steel 27/30 mm, adjustable height, with tilt
- **Ribs:** anodized ribs 4,50 mm grey powder coated
- **Accessories:** type de-luxe grey
- **Weight** for base **Kg** > 20 Kg

Pezzi di ricambio disponibili

Spare parts on demand

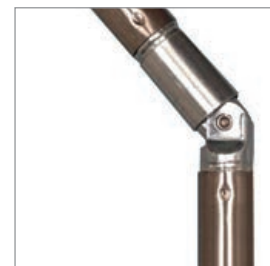

Colori / Colours

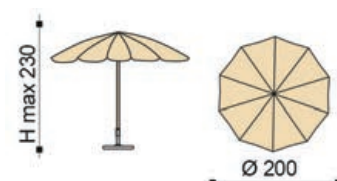
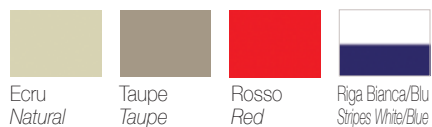



Art. 102K cm 100/8 – D 200

TESSUTO

- PolyMa poliestere gr 210
- Idrorepellente
- Antimuffa
- Resistenza colori 6+
- Protezione UV 50+
- Laccio di chiusura
- Con volantini
- Imballo: scatole x 5

TELAIO

- **Palo:** alluminio mm 33/37, altezza fissa, con snodo metallo
- **Bacchette:** acciaio zincate mm 4,50 ad uncino
- **Peso** per base **Kg** > Kg 15

Pezzi di ricambio disponibili

FABRIC

- PolyMa Polyester 210 gr
- Water repellent
- Mouldproof
- Colour fastness 6+
- UV protection 50+
- Tie-band for closing
- With valances
- Packing: cartons x 5

FRAME

- **Pole:** alu 33/37 mm, fixed height, with metal tilt
- **Ribs:** galvanised, 4,50 mm hooked
- **Weight** for base **Kg** > 15 Kg

Spare parts on demand



Colori / Colours

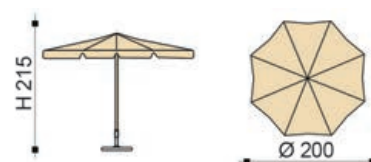



Art. 75/6 cm 125/6 – D 250

TESSUTO

- Tessuto gr 190/210
(vedere dettagli su schema colori)
- Resistenza colore 6+/7
- Protezione UV 20-50+
- Con volant
- Imballo: scatole x 5

TELAIO

- **Palo:** acciaio mm 27/30 grafite, altezza regolabile, snodo metallo
- **Bacchette:** paragon grafite
- **Accessori:** serie de-luxe grafite
- **Peso per base**  > Kg 25

Pezzi di ricambio disponibili

FABRIC

- *Fabric 190/210 gr
(see details on colour scheme)*
- *Colour fastness 6+/7*
- *UV protection 20-50+*
- *With valances*
- *Packing: cartons x 5*

FRAME

- **Pole:** steel 27/30 mm, graphite colour, adjustable height, with metal tilt
- **Ribs:** paragon, graphite colour
- **Accessories:** type de-luxe, graphite
- **Weight for base**  > 25 Kg

Spare parts on demand

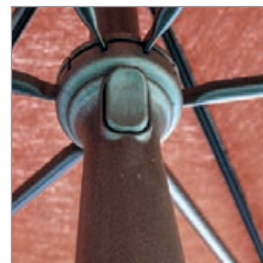

P = PolyMa gr 210 idrorepellente/*PolyMa 210 gr water repellent*
T = TexMa gr 190 idrorepellente/*TexMa 190 gr water repellent*

Colori / Colours

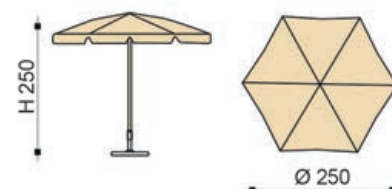



Art. 72 cm 100/8 – D 200

TESSUTO

- Dralon gr 190 finitura sun
- Resistenza colore 5-7
- Protezione UV 20-50+
- Con volanti
- Imballo: scatole x 5

TELAIO

- **Palo:** acciaio mm 33/33 grigio, altezza fissa, con snodo*
- **Bacchette:** acciaio mm 3,80 bianche
- **Accessori:** grigi
- **Peso** per base > Kg 15

Pezzi di ricambio disponibili

FABRIC

- Dralon 190 gr Sun finish
- Colour fastness 5-7
- UV protection 20-50+
- With valances
- Packing: cartons x 5

FRAME

- **Pole:** steel mm 22/25 white, adjustable height, with metal tilt**
- **Ribs:** steel 3,80 mm white
- **Accessories:** type de-luxe white
- **Weight** for base > 15 Kg

Spare parts on demand



*TELAIO PER MERCATO ITALIANO mm 33/33 colore grigio

**FRAME FOR EUROPE (except Italy) 22/25 mm colour white

Disegni / Designs

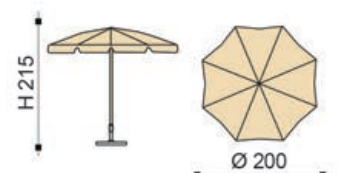
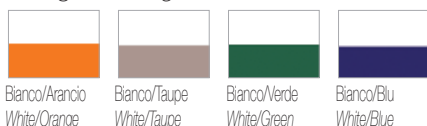



Art. 12 cm 100/8 – D 200

TESSUTO

- PolyMa poliestere gr 210
- Impermeabile
- Antimuffa
- Resistenza colori 6+
- Protezione UV 50+
- Con volanti
- Imballo: scatole x 5

FABRIC

- PolyMa Polyester 210 gr
- Waterproof
- Mouldproof
- Colour fastness 6+
- UV protection 50+
- With valances
- Packing: cartons x 5

TELAIO

- **Palo:** acciaio mm 33/33 grigio, altezza fissa, con snodo*
- **Bacchette:** acciaio mm 3,80 bianche
- **Accessori:** grigi
- **Peso per base** > Kg 15

FRAME

- **Pole:** steel 22/25 mm white, adjustable height, with metal tilt**
- **Ribs:** steel 3,80 mm white
- **Accessories:** type de-luxe white
- **Weight for base** > 15 Kg

Pezzi di ricambio disponibili

Spare parts on demand



*TELAIO PER MERCATO ITALIANO mm 33/33 colore grigio

**FRAME FOR EUROPE (except Italy) 22/25 mm colour white

Colori / Colours

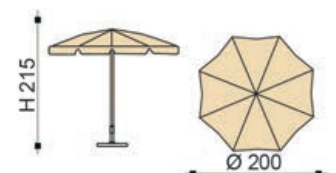



Art. 6 cm 100/8 – D 200

TESSUTO

- Tnt gr 100
- Ricoperto rafia
- Resistenza colori 6+
- Protezione dalla luce molto buona
- Rafia tinta unita
- Imballo: scatole x 2

FABRIC

- Tnt 100 gr
- Covered with rafia
- Colour fastness 6+
- Very good protection from sunlight
- Solid colour rafia
- Packing: cartons x 2

TELAIO

- **Palo:** acciaio mm 33/33 grigio, altezza fissa, con snodo
- **Bacchette:** acciaio bianche
- **Accessori:** grigi
- **Peso** per base **kg** > Kg 15

FRAME

- **Pole:** steel 33/33 mm grey, fixed height, with tilt
- **Ribs:** steel white
- **Accessories:** silver
- **Weight** for base **kg** > 15 Kg

Pezzi di ricambio disponibili

Spare parts on demand

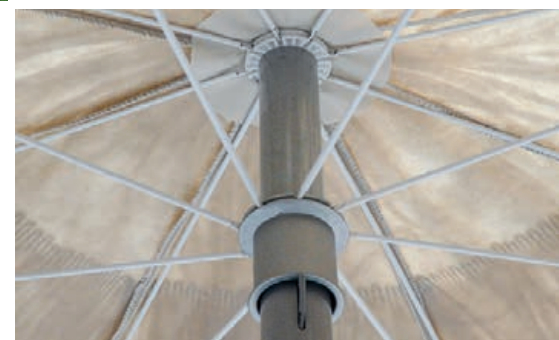

Colori / Colours

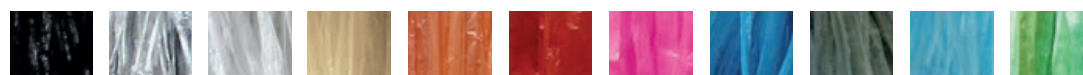

Nero Black Argento Silver Bianco* White* Ecrù Natural Arancio Orange Rosso Red Fucsia Fuchsia Blu Blue Verde Green Azzurro Sky blue Lime Lime

* Fusto bianco / White frame

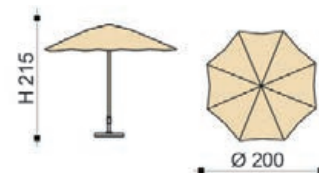



Ecru/Whisky/Marrone - Natural/Whisky/Brown



Bianco/Turchese/Blu - White/Turquoise/Blue



Bianco/Grigio/Nero - White/Silver/Black



Interno - Inside

Art. 7 cm 100/8 – D 200

TESSUTO

- Tnt gr 100
- Ricoperto rafia
- Resistenza colori 6+
- Protezione dalla luce molto buona
- 3 colori rafia
- Imballo: scatole x 2

TELAIO

- **Palo:** acciaio mm 33/33 grigio, altezza fissa, con snodo
- **Bacchette:** acciaio mm 3,80 bianche
- **Accessori:** grigi
- **Peso** per base  > Kg 15

Pezzi di ricambio disponibili

FABRIC

- Tnt 100 gr
- Covered with rafia
- Colour fastness 6+
- Very good protection from sunlight
- 3 colours of rafia
- Packing: cartons x 2

FRAME

- **Pole:** steel 33/33 mm grey, fixed height, with tilt
- **Ribs:** steel 3,80 mm white
- **Accessories:** silver
- **Weight** for base  > 15 Kg

Spare parts on demand

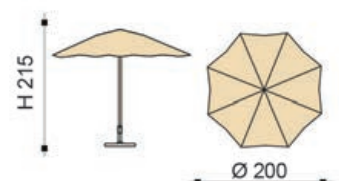



Art. 114R cm 210x130/4

Art. 115R cm 240x150/4

TESSUTO

- Poliestere standard gr 140
- Resistenza colori 4-6
- Con volanti
- Art. 114R - scatole x 5
- Art. 115R - scatole x 1

FABRIC

- Standard polyester 140 gr
- Colour fastness 4-6
- With valances
- Art. 114R - cartons x 5
- Art. 115R - cartons x 1

TELAIO

- **Palo:** acciaio mm 27/30 grafite, altezza regolabile, con snodo
- **Bacchette:** paragon, grafite,
- **Peso** per base > Kg 20 Art. 114R > Kg 25 Art. 115R

FRAME

- **Pole:** steel 27/30 mm, graphite, adjustable height, with metal tilt
- **Ribs:** paragon, graphite
- **Weight** for base > 20 Kg Art. 114R > 25 Kg Art. 115R

Pezzi di ricambio disponibili

Spare parts on demand

Colori / Colours

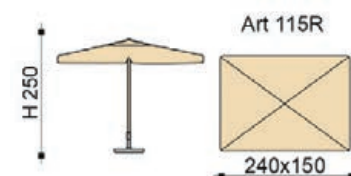
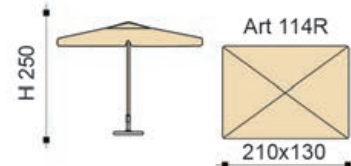



Art. 113Q



Art. 113R



Art. 113Q cm 155x155/4

Art. 113R cm 185x125/4

TESSUTO

- Poliestere standard gr 140
- Resistenza colori 4-6
- Art. 113Q **senza volanti**
Art. 113R **con volanti**
- Imballo: scatole x 5

FABRIC

- Standard polyester 140 gr
- Colour fastness 4-6
- Art. 113Q **without valances**
Art. 113R **with valances**
- Packing: cartons x 10

TELAIO

- **Palo:** acciaio mm 27/30 bianco, altezza regolabile, con snodo
- **Bacchette:** paragon
- **Peso per base** > Kg 15

FRAME

- **Pole:** steel 22/25 mm, graphite, adjustable height, with metal tilt
- **Ribs:** paragon
- **Weight for base** > 15 Kg

Pezzi di ricambio disponibili

Spare parts on demand



**TELAIO PER MERCATO ITALIANO mm 27/30 colore bianco



**FRAME FOR EUROPE (except Italy) mm 22/25 grafite

Colori / Colours

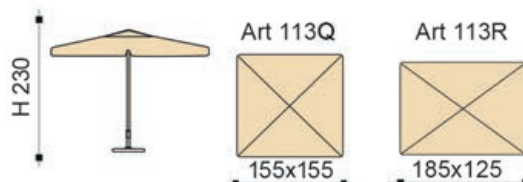
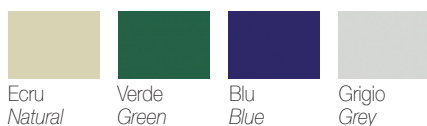



Art. 114



Art. 112

Art. 111 cm 90/8 – D 180 **Art. 112** cm 100/8 – D 200

Art. 114 cm 120/10 – D 240

TESSUTO

- Poliestere standard gr 140
- Resistenza colori 4-6
- Con volanti
- Imballo: scatole x 5

FABRIC

- Standard polyester 140 gr
- Colour fastness 4-6
- With valances
- Packing: cartons x 5

TELAIO

- **Palo:** Art. 111 acciaio mm 22/25 bianco, altezza regolabile con snodo**
Art. 112/114 acciaio mm 33/33 bianco, altezza fissa, snodo*
- **Bacchette:** acciaio bianche
- **Peso** per base **Kg** > Kg 15 Art. 111/112
> Kg 25 Art. 114

FRAME

- **Pole:** Art. 111/112 steel 22/25 mm white, adjustable height, with tilt**
Art. 114 steel 33/33 mm white, fixed height, with tilt*
- **Ribs:** steel white
- **Weight** for base **Kg** > 15 Kg Art. 111/112
> 25 Kg Art. 114

Pezzi di ricambio disponibili

Spare parts on demand

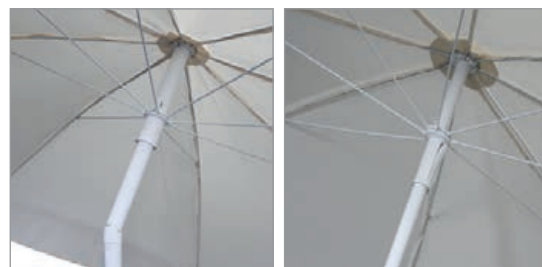

*TELAIO PER MERCATO ITALIANO mm 33/33 colore bianco (eccetto art. 111) **FRAME FOR EUROPE (except Italy) mm 22/25 colour white

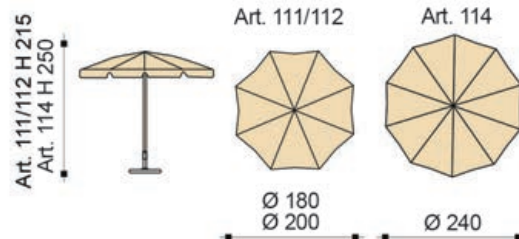

Colore / Colour Art 111

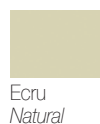

Colori / Colours Art 112

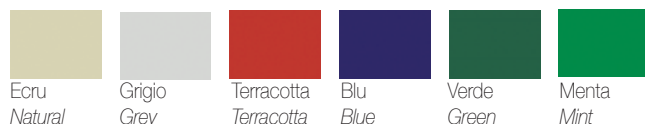

Colori / Colours Art 114





Art. 181A cm 100/8 – D 200

Art. 182A cm 115/8 – D 230

TESSUTO

- Cotone duplex gr 200 unito/stampato o unito/unito
- Resistenza colori 5-6
- Protezione UV buona
- Laccio di chiusura
- Art. 181A **con volanti**
Art. 182A **senza volanti**
- Imballo: scatole x 5

FABRIC

- Duplex cotton 200 gr solid/printed or solid/solid
- Colour fastness 5-6
- UV protection good
- Tie-band for closing
- Art. 181A **with valances**
Art. 182A **without valances**
- Packing: cartons x 5

TELAIO

- **Palo:** alluminio mm 33/37, altezza fissa, con snodo metallo
- **Bacchette:** acciaio zincate mm 4,50 ad uncino
- **Peso per base** > Kg 15

FRAME

- **Pole:** alu 33/37 mm, fixed height, with metal tilt
- **Ribs:** galvanised, 4,50 mm hooked
- **Weight for base** > 15 Kg

Pezzi di ricambio disponibili

Spare parts on demand

Colori / Colours Art 181A



Colori / Colours Art 182A

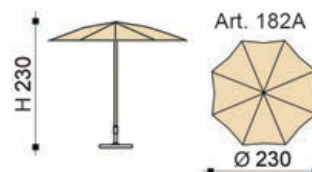
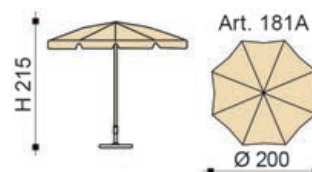



Taupe/Ecru
Taupe/Natural



Ecru/Taupe
Natural/Taupe



Blu/Bianco-Blu
Blue/White-Blue



Verde/Bianco-Verde
Green/White-Green



Taupe/Bianco-Taupe
Taupe/White-Taupe

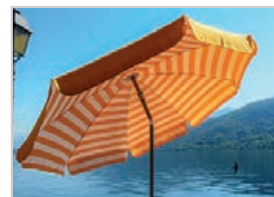

Giallo/Bianco-Giallo
Yellow/White-Yellow



Art. 181 cm 100/8 – D 200

TESSUTO

- Cotone duplex gr 200, unito/stampato o unito/unito
- Resistenza colori 5-6
- Protezione UV buona
- Con volantini
- Imballo: scatole x 5

FABRIC

- Duplex cotton 200 gr solid/printed or solid/solid
- Colour fastness 5-6
- UV protection good
- With valances
- Packing: cartons x 5

TELAIO

- **Palo:** acciaio mm 33/33 grigio, altezza fissa, con snodo*
- **Bacchette:** acciaio
- **Accessori:** grigi
- **Peso** per base > Kg 15

FRAME

- **Pole:** steel 22/25 mm white, adjustable height, with metal tilt**
- **Ribs:** steel
- **Accessories:** white
- **Weight** for base > 15 Kg

Pezzi di ricambio disponibili

Spare parts on demand



*TELAIO PER MERCATO ITALIANO mm 33/33 colore grigio



**FRAME FOR EUROPE (except Italy) 22/25 mm colour white

Colori / Colours

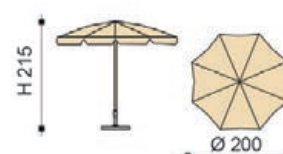

MAFFEI E' ANCHE...

La collezione comprende anche vele, fodere, basi e cuscini in coordinato che permettono di offrire una gamma completa di qualità Maffei.

MAFFEI, NOT ONLY PARASOLS...

Maffei's collection includes shade sails, protection covers, bases and matching cushions which comply with our manufacturing quality.







Art. 1503 cm 300x400x400

Art. 1504 cm 400x400x400

Art. 1505 cm 500x500x500

TESSUTO

- PolyMa poliestere gr 210
- Impermeabile
- Antimuffa
- Resistenza colori 6+
- Protezione UV 50+
- Angoli rinforzati
- Inclusi: corde per angoli e agganci per muro in acciaio inox
- Imballo: scatole x 1

Pezzi di ricambio disponibili

FABRIC

- PolyMa Polyester 210 gr
- Waterproof
- Mouldproof
- Colour fastness 6+
- UV protection 50+
- Reinforced corners
- Included: ropes for corners and stainless steel hooks for wall
- Packing: cartons x 1

Spare parts on demand



Colori / Colours

- | | | |
|-----------------|-----------------|--|
| | | |
| Bianco
White | Ecru
Natural | altri colori
other colours
su richiesta
on demand |

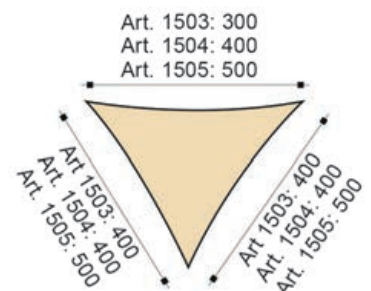

ALLEGRO
Art. 731

cm 78 ca.

Art. 731 cm 190x58x5

TESSUTO

- Art 731 Dralon gr 190 finitura sun
- Resistenza colori 5-7
- Laccetti
- Sfoderabile con cerniera
- Imballo: sacchetti x 1/scatoloni x 12

RIEMPIMENTO

- Poliuretano o poliuretano+ovatta
- Densità: 18
- Spessore: cm 5

FABRIC

- Art 731 Dralon 190 gr Sun finish
- Colour fastness 5-7
- Tie-bands
- Removable cover with zip
- Packing: bag x 1/big cartons x 12

FILLING

- Polyurethane or polyurethane+dacron
- Density: 18
- Thickness: 5 cm



Colori / Colours



Ecu Natural Taupe Terracotta Verde Green

Colori speciali / Special colours



Bianco White Turchese Turquoise Blu Blue Lime



Art. 721

Art. 721 cm 90x45x5

TESSUTO

- Dralon gr 190 finitura Sun
- Resistenza colori 5-7
- Laccetti
- Sfoderabile con cerniera
- Imballo: sacchetti x 1
/scatoloni x 36

RIEMPIMENTO

- Poliuretano o poliuretano+ovatta
- Densità: 18
- Spessore: cm 5

FABRIC

- *Dralon 190 gr Sun finish*
- *Colour fastness 5-7*
- *Tie-bands*
- *Removable cover with zip*
- *Packing: bag x 1
/big cartons x 36*

FILLING

- *Polyurethane or polyurethane+dacron*
- *Density: 18*
- *Thickness: 5 cm*



Colori / Colours



Colori speciali / Special colours





Art. 700 cm 40x40x5

Art. 701 cm 45x45x5

TESSUTO

- Art 700-701 Dralon gr 190 finitura Sun
- Resistenza colori 5-7
- Laccetti
- Sfoderabile con cerniera
- Imballo: sacchetti x 2/scatoloni x 48

RIEMPIMENTO

- Poliuretano
- Densità: 18
- Spessore: cm 5

FABRIC

- Art 700-701 Dralon 190 gr Sun finish
- Colour fastness 5-7
- Tie-bands
- Remouvable cover with zip
- Packing: bag x 2/big cartons x 48

FILLING

- Polyurethane
- Density: 18
- Thickness: 5 cm

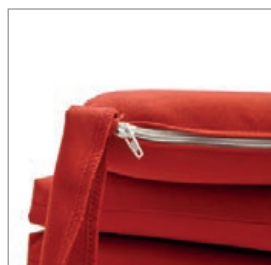

Colori / Colours



Ecu Natural Taupe Taupe Rosso Red Verde Green

Colori speciali / Special colours



Giallo Yellow Turchese Turquoise



MYTEX

Mytex è il tessuto esclusivo di Maffei per le fodere di protezione per esterno. Il tessuto è composto da 3 strati accoppiati che, insieme, hanno la capacità di essere

- IMPERMEABILI
- TRASPIRANTI

Il tessuto ha un'impermeabilità di mm 1200 ed è classificato altamente traspirante. Ha una resistenza alla trazione ed alla lacerazione (chiodo) molto buone ed una finitura anti-UV. Lasciando uscire l'umidità ed essendo impermeabili, gli oggetti al di sotto saranno ben protetti durante tutto l'anno, con una forte riduzione della possibilità di formazione di ruggine o muffa.

MYTEX

MYTEX is the Maffei's exclusiv fabric for protection covers.

The fabric is composed by three layers and is:

- WATERPROOF
- BREATHABLE

Our fabric is waterproof at mm 1200 and the water vapour transmission is very good. It has very good resistance to tensile strenght and to nail tear strenght. It's anti-UV finish too. Being breathable, but waterproof, the humidity can exit and so the object covered will be well protected all the year long and strong reduced the possibility of rust or mould.

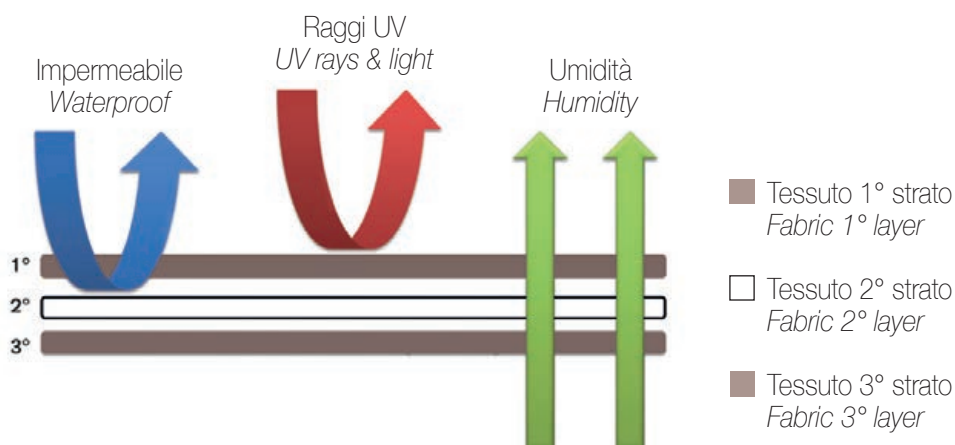

Art. 920 cm 140x30

- Per ombrelloni fino a mt 2
- For parasols till 2 mt

Art. 920R cm 160x45

- Per ombrelloni rafia cm 200 - Maffei Art. 6 e 7
- For raffia parasols 200 cm - Maffei Art. 6 and 7

Art. 921 cm 200x30

- Per ombrelloni fino a mt 3/rettangolare mt 3x2
- For parasols till 3 mt/rectangular 3x2 mt



Art. 920
920R
921



Art. 922 cm 260x49

- Per ombrelloni a palo centrale fino a mt 3x4 e laterali ripiegabili fino a mt 3x2
- For parasols with central pole till 3x4 mt and folding side pole till 3x2 mt



Art. 922



Con bastone
With pole



Art. 922T cm 275x57

- Per ombrelloni telescopici a palo centrale fino a mt 3x4 e laterali ripiegabili fino a mt 3x3 Maffei Art 139Q-140Q-141Q-226-227-448Q-449R
- For telescopic parasols till mt 3x4 mt folding side pole till 3x3 mt Maffei Art 139Q-140Q-141Q-226-227-448Q-449R



Art. 922T



Con bastone
With pole



Art. 923 cm 310x60

■ Per ombrelloni laterali a braccio fisso fino a mt 3x4
Maffei Art. 157-158-159

■ *For fixed arm side pole till 3x4 mt*
Maffei Art. 157-158-159



Con bastone
With pole



Art. 923

Art. 924 cm 130x29

■ Fodera con tracolla rinforzata in Mytex,
per ombrelloni fino a Ø cm 250
Ideale per combinazione ombrellone +
MafTello

■ *Cover made of Mytex with straightened*
shoulder strap, for umbrellas up to Ø 250 cm,
ideal to combine umbrella + MafTello

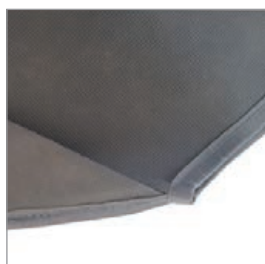

Art. 925 cm 275x55x35

■ Per ombrelloni a palo retrattile fino a mt 4x4
Maffei Art. 188Q-189R-208Q-209R

■ *For side folding umbrellas up to 4x4 mt*
Maffei Art. 188Q-189R-208Q-209R



Con bastone
With pole



Art. 929 cm 65x65x90/120

- Per sedie a schienale basso impilate
- For stacked low back chairs

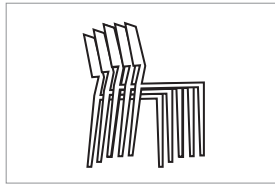

Art. 933 cm 190x72x37/37

Art. 934 cm 210x72x37/37

- Per lettini
- For sun beds

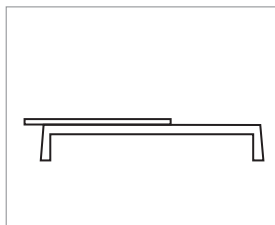

Art. 935 cm 190x100x80

Art. 936 cm 160x100x80

Art. 939 cm 230x130x90

- Per tavoli rettangolari/set tavolo + sedie
- For rectangular table/set table + chairs

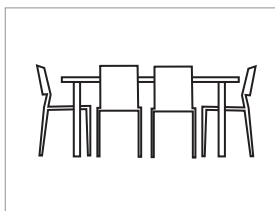

Art. 937 cm 100x100x80

- Per tavoli quadrati/set tavolo + sedie
- For square table/set table + chairs

Art. 938 cm 230x130x90

- Per tavoli ovali/set tavolo + sedie
- For oval table/set table + chairs

Art. 965 cm 80x70x75

Art. 966 cm 140x70x105

Art. 967 cm 180x72x105

- Per BBQ - piccolo / medio / grande
- For BBQ - little / medium / large

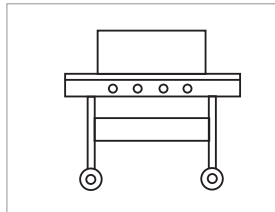
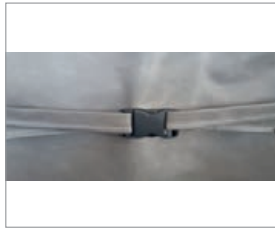

Art. 986 cm 220x150x160

- Per dondolo
- For swing chair

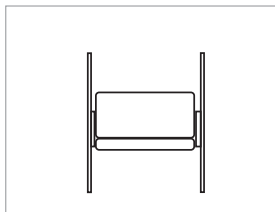

Art. 950 cm 170x60x110/30

- Per tagliaerba
- For lawn mower

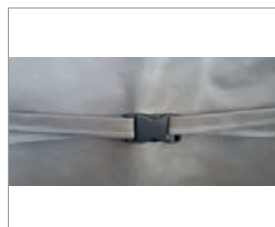

Art. 955 cm 210x90x120

- Per trattorino tagliaerba
- For little tractor

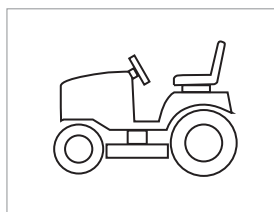

Art. 961 cm 152x95/40x160

- Per tavolo ping pong
- For tennis table

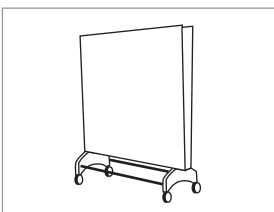
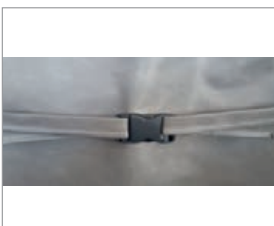

SERVIZIO FODERE SU MISURA
SERVICE COVERS ON DEMAND

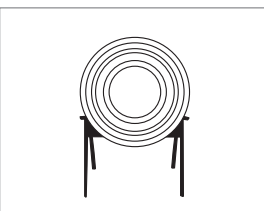
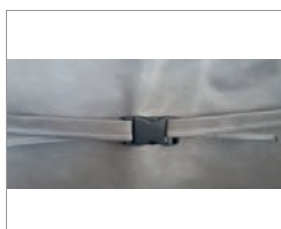



Art. 356-BIA-38 tubo/tube 38 mm
Art. 356-BIA-45 tubo/tube 45 mm
Art. 356-BIA-55 tubo/tube 55 mm
 cm 62x62x1 – kg 30

- Base in metallo calpestabile, colore bianco, predisposizione ruote/tasselli
- *Metal walkable base, white colour, with holes to assemble wheels/anchors*



Art. 358-BIA-38 tubo/tube 38 mm
Art. 358-BIA-45 tubo/tube 45 mm
 cm 62x62x0,6 – kg 20

- Base metallica calpestabile, colore bianco, predisposizione ruote/tasselli
- *Metal walkable base, white colour, with holes to assemble wheels/anchors*



Art. 356Y-BIA-55 tubo/tube 55 mm
Art. 356Y-BIA-65 tubo/tube 65 mm
 cm 62x62x1,6 – kg 50

- Base metallica calpestabile, colore bianco, predisposizione ruote/tasselli, composta da due piastre sovrapposte
- *Metal walkable base, white colour, with holes to assemble wheels/anchors. The base is made by two stacked plates.*



Art. 356-GRA-38 tubo/tube 38 mm
Art. 356-GRA-45 tubo/tube 45 mm
Art. 356-GRA-55 tubo/tube 55 mm
 cm 62x62x1 – kg 30

- Base metallica calpestabile, colore grafite, predisposizione ruote/tasselli
- *Metal walkable base, graphite colour, with holes to assemble wheels/anchors*



Art. 358-GRA-38 tubo/tube 38 mm
Art. 358-GRA-45 tubo/tube 45 mm
 cm 62x62x0,6 – kg 20

- Base metallica calpestabile, colore grafite, predisposizione ruote/tasselli
- *Metal walkable base, graphite colour, with holes to assemble wheels/anchors*



Art. 356Y-GRA-55 tubo/tube 55 mm
Art. 356Y-GRA-65 tubo/tube 65 mm
 cm 62x62x1,6 – kg 50

- Base metallica calpestabile, colore grafite, predisposizione ruote/tasselli, composta da due piastre sovrapposte
- *Metal walkable base, graphite colour, with holes to assemble wheels/anchors. The base is made by two stacked plates*



Art. 320-BIA-27
 D cm 44 – kg 27

- Base in cemento ricoperta plastica con tubo, adatta a bastoni ombrelloni mm 40. Disponibile adattatore per misure diverse.
- *Concrete base covered with resin, with tube, fits umbrellas with pole 40 mm. Adaptors for smaller/larger poles are available.*



Art. 320-BIA-54
 D cm 44 – kg 54

- Base in cemento ricoperta plastica con tubo, adatta a bastoni ombrelloni mm 40. Disponibile adattatore per misure diverse. Composta da due dischi sovrapposti.
- *Concrete base covered with resin, with tube, fits umbrellas with pole 40 mm. Adaptors for smaller/larger poles are available. The base is made by two stacked disk..*



Art. 322-BIA
 D cm 44 – kg 27

- Set base e tavolino. Adatto a bastoni ombrelloni mm 40. Disponibile adattatore per misure più piccole.
- *Set base and table. Fits umbrellas with pole 40 mm. Adaptor for smaller pole is available.*





Art. 304-38 tubo/tube 38 mm
Art. 304-45 tubo/tube 45 mm
 cm 50x50x3,6 – kg 20

- Base in cemento disegno legno, grigio
- *Concrete base with wood design, grey*



Art. 304B-38 tubo/tube 38 mm
Art. 304B-45 tubo/tube 45 mm
 cm 50x50x3,6 – kg 20

- Base in cemento disegno legno, grigio
- *Concrete base with wood design, grey*



Art. 304X-55 tubo/tube 55 mm
Art. 304X-65 tubo/tube 65 mm
 cm 50x50x7,2 – kg 40

- Base in cemento disegno legno, grigio. La base è composta da nr. 2 piastrelloni sovrapposti.
- *Concrete base with wood design, grey. The base is composed by 2 stacked tiles.*



Vite di sicurezza
 Safety screw



Art. 304-MA-38 tubo/tube 38 mm
Art. 304-MA-45 tubo/tube 45 mm
 cm 50x50x3,6 – kg 20

- Base in cemento disegno legno, marrone
- *Concrete base with wood design, brown*



Art. 304B-MA-38 tubo/tube 38 mm
Art. 304B-MA-45 tubo/tube 45 mm
 cm 50x50x3,6 – kg 20

- Base in cemento disegno legno, marrone
- *Concrete base with wood design, brown*



Art. 304X-MA-55 tubo/tube 55 mm
Art. 304X-MA-65 tubo/tube 65 mm
 cm 50x50x7,2 – kg 40

- Base in cemento disegno legno, marrone. La base è composta da nr. 2 piastrelloni sovrapposti.
- *Concrete base with wood design, brown. The base is composed by 2 stacked tiles.*



Vite di sicurezza
 Safety screw



Art. 304-BIA-38 tubo/tube 38 mm
Art. 304-BIA-45 tubo/tube 45 mm
 cm 50x50x3,6 – kg 20

- Base in cemento disegno legno, bianco
- *Concrete base with wood design, white*



Art. 304B-BIA-38 tubo/tube 38 mm
Art. 304B-BIA-45 tubo/tube 45 mm
 cm 50x50x3,6 – kg 20

- Base in cemento disegno legno, bianco
- *Concrete base with wood design, white*



Art. 304X-BIA-55 tubo/tube 55 mm
Art. 304X-BIA-65 tubo/tube 65 mm
 cm 50x50x7,2 – kg 40

- Base in cemento disegno legno, bianco. La base è composta da nr. 2 piastrelloni sovrapposti.
- *Concrete base with wood design, white. The base is composed by 2 stacked tiles.*



Vite di sicurezza
 Safety screw



Art. 301-38 tubo/tube 38 mm
Art. 301-45 tubo/tube 45 mm
Art. 301-55 tubo/tube 55 mm
Art. 301-65 tubo/tube 65 mm

D cm 54 – kg 35

- Base graniglia
- Grit base



Art. 302-38 tubo/tube 38 mm
Art. 302-45 tubo/tube 45 mm

D cm 44 – kg 25

- Base graniglia
- Grit base



Art. 302-15-38 tubo/tube 38 mm

D cm 42 – kg 15

- Base graniglia
- Grit base



Art. 310-55 tubo/tube 55 mm
Art. 310-65 tubo/tube 65 mm

D cm 54 – kg 35

D cm 59 – kg 55

- Base in graniglia con maniglie.
- Grit base with handles.



Art. 311-65 tubo/tube 65 mm

D cm 65 – kg 75

- Base in graniglia con maniglie.
- Grit base with handles.

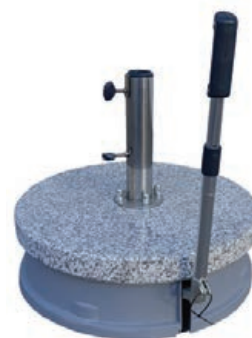

Art. 360

D cm 58 – kg 45

- Base in granito con ruote.
- Granite base with wheels.

Tubo/tube mm 38 - per pali ombrelloni fino a/for parasol poles up to 33 mm
Tubo/tube mm 45 - per pali ombrelloni/for parasol poles 30-38 mm

Tubo/tube mm 55 - per pali ombrelloni/for parasol poles 40-48 mm
Tubo/tube mm 65 - per pali ombrelloni/for parasol poles 50-60 mm



Art. 300

cm 38x38x11 – 15 L

- Base plastica bianca con tubo, per pali mm 25-33.
- White plastic base with tube, for poles 25-33 mm.



Art. 300-45R

cm 46x46x22 – 45 L

- Base plastica bianca con ruota e tubo per pali mm 33-50.
- White plastic base with wheel, for tubes 33-50 mm.



Art. 300-45R-GRA

cm 46x46x22 – 45 L

- Base plastica grafite con ruota e tubo per pali mm 33-50.
- Graphite plastic base with wheel, for tubes 33-50 mm.

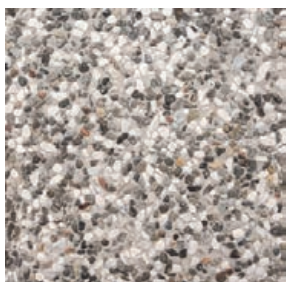

Art. 303

cm 50x50x3,7
kg 20

- Piastrellone in graniglia
- Grit tile



Art. 305

cm 50x50x3,6
kg 20

- Piastrellone in cemento disegno legno, grigio
- Concrete tile with wood design, grey



Art. 305-MA

cm 50x50x3,6
kg 20

- Piastrellone in cemento disegno legno, marrone
- Concrete tile with wood design, brown



Art. 305-BIA

cm 50x50x3,6
kg 20

- Piastrellone in cemento disegno legno, bianco
- Concrete tile with wood design, white

Art. 352

- Base da interrare in alluminio per ombrelloni a palo centrale composta da trivella calpestabile e supporto. Si adatta a pali ombrelloni mm 20-50.

- Ground base for side pole parasols composed by a walkable drill and a support. Fits parasols poles 20-50 mm.

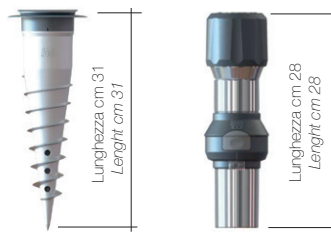

Adattatore
Holder



Supporto + Trivella
Holder + drill



Calpestabile
Walkable

Art. 353

- Base da interrare in alluminio per ombrelloni laterali composta da trivella calpestabile e supporto.

- Ground anchor for side umbrellas made by a walkable drill and a support.



Supporto + Trivella
Holder + drill



“Noi produciamo” “We manufacture”

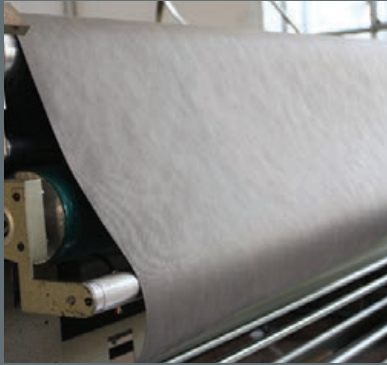

MAFFEI S.R.L.

Via Donizetti, 1

28021 Borgomanero (NO) - Italy

Tel. +39.0322.81819

E-mail: maffei@maffeisrl.com

www.maffeisrl.com

www.ombrelloniprofessionali.it

RINGRAZIAMENTI

Agriturismo La Capuccina - Cureggio (NO) - www.lacapuccina.it

Motonautica San Giulio - Pella (NO) - www.msg-bassotto.it

Comune di Pella (NO)

Castello Dal Pozzo - Oleggio castello (NO) - www.castellodalpozzo.com

Villa Claudia - Belgirate (NO) - www.villaclaudiadalpozzo.com



www.maffeisrl.com



www.ombrelloniprofessionali.it